

DYNAMICS OF FOREST AND THICKET VEGETATION
ON THE ACCRA PLAINS, GHANA

DIANA DALE LIEBERMAN



A thesis presented to
The University of Ghana
for the degree of
Doctor of Philosophy

June 1979

UNIVERSITY OF GHANA LIBRARY
ACCREDITED BY THE NATIONAL LIBRARY AUTHORITY



OL 402.G5L62

David Ross

G279271



UNIVERSITY OF GHANA
LIBRARY
ACCREDITED BY THE NATIONAL LIBRARY AUTHORITY

DEPARTMENT OF BOTANY

UNIVERSITY OF GHANA

LEGON

This is to certify that the work presented in this thesis was carried out entirely by myself, and all assistance has been duly acknowledged.

This thesis has never been presented, either in part or in whole, for a degree of any other University.

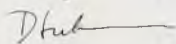

Diana Lieberman

J.B. Hall
Supervisor

CONTENTS

	Page
Vol. 1. ABSTRACT	i
ACKNOWLEDGEMENTS	iv
INTRODUCTION	1
STUDY AREA	
The Accra Plains	3
Pinkwae	10
History	19
Utilisation	21
SEASONALITY AND PHENOLOGY	
Introduction	25
Methods	44
Results	
Seasonality	52
Flowering and Fruiting	57
Foliage Behaviour	66
Girth Changes	75
REGENERATION AND GROWTH	
Introduction	80
Methods	89



	Pages
Results	
Seedling Studies ...	96
Soil Seed Stocks ...	104
Vegetative Regeneration ...	108
Size Class Distributions ...	111
<u>Lannea nigritana</u> ...	122
Tree Growth Rates ...	129
Allometry ...	132
STRUCTURE AND DYNAMICS	
Introduction ...	135
Methods ...	144
Results	
Transect ...	148
Basal Area ...	151
Species Dispersion Patterns	153
Physical Structure ...	157
Floristic Variation and Dynamics	162
Forest Cover ...	171
DISCUSSION	
Phenology ...	174
Regeneration ...	182
Dynamics ...	193



	Page
REFERENCES	204
VOL. 2 APPENDIX 1. Systematic list of plant species occurring in the Pinkwae area	223
APPENDIX 2. Partial list of vertebrate species occurring in Pinkwae ...	230
APPENDIX 3. Rainfall and phenology sampling dates, 1976 - 1979 ...	235
APPENDIX 4. List of species flowering, fruiting, or flushing, with code numbers	239
APPENDIX 5. Phenological records ...	243a
APPENDIX 6. Girth change records for trees of 12 species, 1978 - 1979 ...	250
APPENDIX 7. Seedling standing crop, mortality and recruitment ...	273
APPENDIX 8. Plot descriptions ...	285
APPENDIX 9. Species lists for 37 plots of 0.01 ha each	294
APPENDIX 10. Girth summaries of the 13 most abundant tree species, by plot	298

LIST OF FIGURES

	Page
Frontispiece. Aerial photograph of Pinkwae.	—
Fig. 1. Map of southeastern Ghana.	3a
Fig. 2. Map of Pinkwae area.	9a
Fig. 3. Aerial photograph of forest patch south of Pinkwae.	9c
Fig. 4. Levelling profile of 200 m transect through thicket clumps near Madina.	9e
Fig. 5a. Levelling profile of 580 m transect through Pinkwae.	10a
Fib. 5b. Map of Pinkwae with sampling sites.	10c
Fig. 6. Margin of the forest.	10e
Fig. 7. Base of large <u>Antiaris africana</u> near margin.	10e
Fig. 8. Tree of <u>Chaetacme aristata</u> .	14a
Fig. 9. Large climber filled gap in forest.	14a
Fig. 10. Soil pit under closed canopy forest.	15a
Fig. 11. Old eroded termite mound inside forest.	15a
Fig. 12. Banded tree of <u>Lannea acida</u> .	18a
Fig. 13. Leafless tree of <u>Gardenia ternifolia</u> .	18a
Fig. 14. Shoot of <u>Zanthoxylum xanthoxyloides</u> .	35a
Fig. 15. Regression of rainfall at Amrahia Dairy Farm against rainfall at Pinkwae.	45a
Fig. 16. Caliper and band dendrometer.	49a
Fig. 17. Use of caliper to measure tree too small to band.	49a

Fig. 18. Plot of rainfall during the study period and daylength during the same period.	52a
Fig. 19. Monthly rainfall during the period 1973-78.	52c
Fig. 20. Monthly temperature extremes during the period 1973-78.	53a
Fig. 21. Monthly range of temperature during the period 1973-78.	53c
Fig. 22. Hytherographs for three tropical forest sites.	54a
Fig. 23. Temperature pattern in canopy and understorey during a 48 hr period in the wet and dry seasons.	55a
Fig. 24. Daily march of relative humidity.	55c
Fig. 25. Temperature and humidity ranges in four microhabitats.	55e
Fig. 26. Frequency distribution of wind speed.	55g
Fig. 27. Number of species flowering and fruiting on each sampling date.	57a
Fig. 28. Comparison of reproductive phenology between two years.	57c
Fig. 29. Regression of number of species flowering against rainfall.	58a
Fig. 30. Regression of number of species fruiting against rainfall.	58c
Fig. 31. Ordination of flowering data.	59b
Fig. 32. Ordination of fruiting data.	62a
Fig. 33. Number of species flushing on each sampling date.	66a
Fig. 34. Regression of number of species flushing against rainfall.	66c
Fig. 35. Frequency distributions of (a) mean number of flushing days per flush, and (b) total number of flushing days for each species.	68a

- Fig. 36. Comparison of flush duration in undamaged and herbivore damaged flushes for three groups of species. 69a
- Fig. 37. Frequency distribution of number of flushing days which occurred outside the main flushing periods. 71a
- Fig. 38. Ordination of flushing data. 71c
- Fig. 39. Ordination of flushing data. 72a
- Fig. 40. Girth change patterns in 12 tree species. 75a
- Fig. 41. Girth change patterns in saplings of two species. 78a
- Fig. 42. Mean seedling density in the 11 sample plots during the two year observation period. 96a
- Fig. 43. Total density, diversity, and evenness of seedlings in the permanent seedling plots. 96f
- Fig. 44. Standing crop of seedlings in each species during the two year study period. 999a
- Fig. 45. Pattern of recruitment and mortality of seedlings during the study period. 100a
- Fig. 46. Height specific mortality curves for seedlings of six species. 101a
- Fig. 47. Estimated growth curves for seedlings of four species. 102a
- Fig. 48. Basal area class distribution of trees in 13 species. 111a
- Fig. 49. Patch of large trees of Lannea nigritana. 122a
- Fig. 50. Root sucker of Lannea nigritana showing damage. 122a
- Fig. 51. Growth pattern of shoots of Lannea nigritana root suckers subjected to antelope predation. 124a
- Fig. 52. Height distribution of Lannea nigritana root suckers less than 1 m in height. 124c

- Fig. 53. Basal area class distribution of Lannea nigritana in individual sample plots. 126a
- Fig. 54. Annual girth increment as a function of initial girth. 131a
- Fig. 55. Annual girth increment as a function of initial girth, data pooled for 11 species. 131e
- Fig. 56. Drawings of seven seedling species. 132a
- Fig. 57. Regression of mean crown diameter against trunk diameter for five tree species. 133a
- Fig. 58. Girth of largest tree in 28 sequential plots along a northwest-southeast transect through Pinkwae. 148a
- Fig. 59. Regression of sapling density on tree basal area in plots within Pinkwae. 151b
- Fig. 60. Map of trees on 0.36 ha sample plot in Pinkwae. 154a
- Fig. 61. Frequency distribution of nearest neighbour distances for eight tree species. 154g
- Fig. 62. Plot showing degree of clumping in 14 tree species. 155a
- Fig. 63. Diversity of trees and number of trees sampled for four adjacent samples near a gap. 155c
- Fig. 64. Relative importance of eight tree species in four adjacent samples near a gap. 155e
- Fig. 65. Ordination of stands and species within Pinkwae. 162a
- Fig. 66. Ordination of stands and species within Pinkwae, with soil colour indicated on diagram. 163a
- Fig. 67. Ordination of stands and species from 0.01 ha plots within Pinkwae, with a separate list for mature and immature species. 165a

- Fig. 68. Scatter diagram of ordination scores of canopy species list versus regeneration species lists in each sample plot. 165c
- Fig. 69. Scatter diagram of seedling rank of each species versus adult tree rank of the same species. 166a
- Fig. 70. Ordination of stands and species from thicket and forest vegetation of the Accra Plains. 168a
- Fig. 71. \log_{10} of frequency of species ranked from most to least abundant. 170a

LIST OF TABLES

	Page
Table 1. Range of habitats in which species from Pinkwae are known to occur.	11a
Table 2. Flowering and fruiting patterns, 1976-79.	58e
Table 3. Flowering pattern of four categories of species from the Pinkwae area.	59a
Table 4. Comparison of success of fruit set in dry fruited and fleshy fruited species.	64a
Table 5. Comparison of success of fruit set in species which are classified as common or rare.	65a
Table 6. Comparison of survivorship in unprotected and chemically protected flushes.	70a
Table 7. Comparison of survivorship in unprotected and hairy flushes.	70b
Table 8. Girth range from February 1978 to April 1979 in 12 species from three habitats.	78a
Table 9. Summary of characteristics of 11 permanent seedling plots.	96e
Table 10. Density, diversity, and evenness of forest and thicket seedling populations, 1976-78.	97a
Table 11. Seedlings germinating from grassland ^{and} thicket soil samples.	104a
Table 12. Seedlings germinating from three pairs of forest soil samples.	105a
Table 13. Two way classification of species which germinated from soil samples, based on the source of the soil and the usual habitat of the species.	106a
Table 14. Two way classification of species which germinated from soil samples, based on the suitability of the habitat from which the seed germinated and the seed dispersal mechanism.	107a

Table 15. Frequency of regeneration by seedlings and root suckers in forest and thicket clumps.	108a
Table 16. One tailed runs test for dichotomized data—test of significance of sequence of positive and negative deviations from expected size class frequencies in <u>Lannea nigritana</u> .	113a
Table 17. Estimated size specific survivorship rates of 13 tree species.	117a
Table 18. Mean annual girth increment in 1978-79 for each of 12 tree species.	129a
Table 19. Comparison of rooting depth and root/shoot ratios for seedlings of seven species.	132c
Table 20. Basal area of trees, saplings and climbers in 0.01 ha plots in Pinkwae.	151a
Table 21. Frequency of life forms in forest and thicket near Pinkwae.	157a

Frontispiece

Aerial photograph of Pinkwae, an undisturbed tropical dry forest in the western subscarp zone of the Accra Plains. The forest is approximately 120 ha in area. (The vertical axis is oriented roughly north-south.)



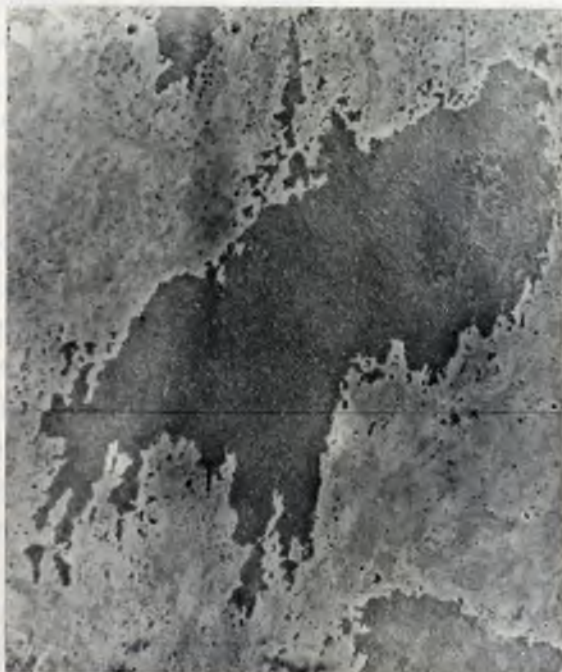

...the ... of the ...

ABSTRACT

Aspects of seasonal dynamics, population dynamics, and successional dynamics were investigated in three kinds of woody vegetation which occur on the Accra Plains: dry tropical forest, large thickets, and isolated clumps of thicket.

Flowering, fruiting, foliage behaviour, and girth changes show a strong seasonal pattern in the study area; moisture deficits limit phenological activity within the community, although patterns vary among species. Synchrony was high within species in reproductive phenology and girth changes, and was high within the community in foliage behaviour. Synchronous flushing was shown to be a significant mechanism of herbivore escape in species lacking alternative defences such as hairy leaves or chemical deterrents. The success rate of fruit set during the study period was low; this probably resulted from both pollination failure and moisture stress. Girth increments for the year were negative, due to the unusually low rainfall.

Patterns of seed dispersal and vegetative regeneration tend to maintain the floristic identity of thicket and forest respectively; little mixing between habitats occurs in the seed rain, and differential mortality of seedlings further constrains the adult species composition in the two habitats. Root suckering is particularly important in thicket clumps, due to the mosaic nature of the habitat. Regeneration is adequate in both thicket and forest to maintain the vegetation in a steady-state, although during the study period, seedling mortality exceeded recruitment.

Species of closed canopy dry forest showed good stocking in all size classes; some gap-exploiting species were deficient in the small size classes or showed a highly irregular size class distribution. In most species, survivorship rates were constant from one size class to the next through the first stage of the tree's growth (up to 20% of its maximum size), improving in the later stage; in two understory species, survivorship rates were constant throughout the lifespan of the tree.

Successional patterns within the forest are dominated by patchy disturbances (caused by tree falls);

gaps are filled by any of a number of rather rare, long-lived emergent species, and old gaps show higher species diversity than is found in other areas. In the absence of disturbance, the composition converges on a low-diversity forest dominated by Diospyros abyssinica, Drypetes parvifolia, and Drypetes floribunda. Most species in the forest show clumped dispersion, resulting from patterns of seed dispersal and vegetative regeneration.

Forest of the Accra Plains appears to be stable under present climatic conditions. Reduced rainfall probably has the effect of reducing the cover of woody vegetation, and the damaging effect of fire and wind may be augmented under particularly dry conditions. Changes in vegetation resulting from drought, fire, and wind are neither rapid nor pronounced. Cutting of wood, however, quickly brings about apparently irreversible changes in the species composition, physiognomy, and stature of the vegetation: a dense, low thicket replaces the forest, and this thicket is, itself, stable under the influence of further cutting. Thicket clumps, which differ floristically from both forest and large thickets, exist as isolated relics of more continuous thicket vegetation where the moisture level is insufficient to support larger patches of woody vegetation.

ACKNOWLEDGEMENTS

For their many stimulating discussions and valuable comments during the course of this study, I am greatly indebted to M.D. Swaine, J.B. Hall, and E. Laing (Supervisors), and to Milton Lieberman and J.M. Lock. Assistance in the field was provided by many people, to all of whom I am most grateful; particular thanks are due to R.S. Amponsah, E.K. Barko, and B. Perry.

I also wish to thank the chief, Nii Laryea Akuete VIII; his son, J.O. Laryea; and the people of Katamanso, without whose cooperation and friendship this study could not have been carried out.

Plant identifications were made by J.B. Hall; bird lists were compiled using the field notes of Sydney Head, Milton Lieberman, Jeffery Short, and G. Van der Sticken; mammals and mammalian skeletal material were identified by Osumanu Nankabenu and P. Grubb, respectively; and reptiles were identified by B. Hughes. Archaeological information was contributed by Joanne C. Dombrowski, I. G. Glover, and J.E.G. Sutton.

The Department of Botany, University of Ghana generously provided logistic and material support for the field work. Computer time was provided by The Computing Centre, University of Ghana. The extended loan of aerial photographs

was arranged by the Ghana Survey Department. Climatic data were supplied by the Ghana Meteorological Services Department; G. Sowah, Amrahia Dairy Farm, kindly provided rain gauge records.

J.B. Hall, M.D. Swaine, and J.M. Lock allowed me access to their unpublished data. Financial support was provided by a Dissertation Fellowship awarded by the American Association of University Women.

INTRODUCTION

The communities considered here comprise a unique 120-ha patch of undisturbed dry forest in the western sub-scarp zone of the Accra Plains, surrounded by a typical mosaic of short, dense thicket and open grassland. Dry forest may once have been more important on the Plains, although little is known of the factors which might determine its distribution. Such forest patches are now quite rare; the only remaining patches occur where wood-cutting is forbidden, either by law or by tradition.

The forest studied in this project, Pinkwae, is a sacred grove which has been protected from wood-cutting for just over 150 years. The patch differs from nearby unprotected thicket in species composition, stature, and physiognomy.

Because of its intrinsic interest as a well-preserved representative of a rare and threatened vegetation type, Pinkwae forms the focus of this study. In a more general context, the forest is of comparative interest as an example of undisturbed tropical dry forest; the topics of seasonality, phenology of reproduction, foliage behaviour, and girth changes, regeneration, growth rates,

demography, population dispersion patterns, community structure, and successional dynamics have never been studied together in a forest community of this type.

In addition, the history of the area and its vegetation presents a valuable opportunity to study the long-term effects of forest protection on the Accra Plains.

STUDY AREA

The Accra Plains

The Accra Plains comprise the triangular area in southeastern Ghana which is bordered to the east by the lower reaches of the Volta River, to the north and west by the Akwapim Scarp, and to the south by the Gulf of Guinea (Fig. 1). The plains cover an area of about 2,800 km².

Because of its distinctive climate (Harrison Church 1963), geology (Bondeson and Smit 1972), soils (Brammer 1967), and vegetation (Lawson and Jenik 1967, Okali 1971, Okali et al. 1973, Jenik and Hall 1976), the plains area has attracted wide interest, and a rather comprehensive literature has developed. Its present isolation from other savanna areas, and its position in the "Dahomey Gap" which divides West African forest into two blocks, gives it phytogeographical (Morton 1962, Jenik and Hall 1976) and zoogeographical (Booth 1958, 1959) interest. Most of the relevant literature is critically reviewed by Jenik and Hall (1976).

The climate of the Plains is unusual in its combination of low rainfall, moderate temperatures and rather high humidity, and has been given the designation "Accra-Togo Dry Coastal Climate" (Harrison Church 1963). The prevailing wind

Figure 1

Map of south-eastern Ghana. Accra Plains indicated by stippling; study area (Pinkwae area) indicated by box. Limits of different forest types, as classified by Hall and Swaine (1976), are indicated by broken lines: SEO, South-east Outlier; SM, Southern Marginal; DSD, Dry Semi-deciduous; MSD, Moist Semi-deciduous; and UE, Upland Evergreen. Regions on the map south of the SEO forest type and northwest of the Volta Lake bear savanna. (After Hall and Swaine, 1979a).

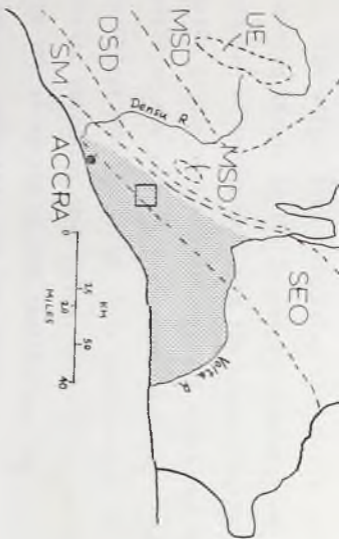



during most of the year blows steadily from the southwest, with the highest velocities occurring in the subscarp zone; for a part of the major dry season, the dust-laden, desiccating Harmattan wind blows from the north. There is a moisture gradient within the plains area, from the wetter part in the north, near Akuse (annual rainfall around 1120 mm) to the dry coastal part between the Volta mouth and Accra (annual rainfall around 730 mm). A concomitant gradient in the length of the growing season has led to the differentiation of grassland vegetation into savanna (wetter areas) and steppe (dry areas) (Jeník and Hall 1976).

The parent rock underlying the plains is mostly Pre-Cambrian gneiss of the Dahomeyan (Bondeson and Smit 1972). This can be subdivided into the weathering-resistant basic gneiss of the northern and central areas and the acidic gneiss of the western and eastern areas. A zone of inselbergs occurs in the basic gneiss area of the central plains, including Shai Hills, Krobo Hill, and others. With the exception of the inselbergs, the topography of the plains is generally low and undulating.

Soils on the plains show much variation. Generally shallow (on the order of two metres), the soils closely reflect the underlying parent rock. The basic gneisses

give rise to nutrient-rich black clay soils (Black Earths) which are physically unstable, tending to swell when wet and to shrink and crack to great depths when dry. The acidic gneisses give rise to regosolic groundwater laterites (Pallid Sands), which have a sandy upper layer above a stone or clay pan, and to the similar but more sodium-rich Grey Earths. The groundwater laterites are subject to waterlogging in the wet season, and are therefore unsuited to the growth of most woody plants. Red Earths develop over Tertiary deposits; they tend to be fairly deep, well-drained soils which, because of their physical properties, are widely used for farming (Jeník and Hall 1976).

Three major vegetation types are recognised on the Accra Plains, based on phytosociological information: these are short grasslands or steppes, belonging to the class Vetiverietea; tall savanna grasslands and open woodlands, belonging to the class Hyparrhenietea; and closed forests and thickets belong to the class Pycnanthetea (Jeník and Hall 1976). The distribution of these vegetation classes can be explained largely in terms of rainfall, while the subgroups which are recognised within each class are associated with particular soils.

It is the third class, Pycnanthetea, with which this thesis is concerned. Within the class, which may be extended

to include most of the lowland closed forest in tropical Africa, a single order occurs on the Accra Plains:

Diospyretalia. This is provisionally subdivided into two alliances, the Diospyrion, comprising stands of dry forest, and the Capparion, comprising areas of thicket vegetation. The Diospyrion is characteristically found on inselbergs while the Capparion occurs within the larger steppe areas.

The Capparion alliance is typically manifested as isolated, discrete clumps of thicket separated by intervening areas of treeless grassland. Interest has been attracted by the unique physiognomy of thicket clumps (Lawson and Jeník 1967, Jeník and Hall 1976): clumps tend to be elongate or even fusiform in shape, and to be oriented parallel to the direction of the prevailing wind (southwest-northeast). Regions within the clump can be distinguished; the "leading" (windward) edge is of lower stature and sparser cover than the middle portion or leeward edges. The leeward edge has a greater diversity of species, many of them relatively fire-sensitive, and the ground in the lee of the clump may support a fairly luxuriant cover of grass. Morphogenic factors have been suggested for this vegetation type, the principal ones being fire (Lawson and Jeník 1967) and wind (Jeník and Hall 1976).

Thicket clumps are generally found to be associated with termite mounds. The dynamic relationships between

mound-building and thicket clump development are complex and have not been satisfactorily elucidated, but the growth of woody vegetation is certainly favoured in termite-worked soil. Termite activity improves porosity, water infiltration, and aeration, and plant roots are better able to penetrate such soil than unworked soil. Mounds are found to concentrate organic carbon, nitrogen, calcium, magnesium, and potassium in relation to surrounding soil (Lee and Wood 1971). The replenishment of top soil and the formation of a gravel-free top soil by termites is considered to be extremely important in termite areas (Nye 1955, Okali et al. 1973).

Examination of aerial photographs reveals that the size and density (in terms of physical spacing) of thicket clumps is least in low-lying areas of ground, and greater on slopes and the summits of low hills. Rather dense concentrations of thicket vegetation (not isolated as clumps) follow the temporary or semi-permanent water-courses which are found on the plains. The cover of thicket also appears to be least in coastal areas and greatest in the northern parts of the plains.

The Diospyron alliance, which corresponds with the South-east Outlier forest type of Hall and Swaine (1976), unites a series of geographically separated but floristically and structurally similar stands of rather low-diversity,

evergreen dry forest. These stands are found on hilltops and on the ~~summits~~ and slopes of inselbergs in the plains area. Such patches are restricted to the central and northern portion of the plains, developing only under fairly high rainfall conditions. The fact that these floristically similar patches of forest are isolated from one another, and are found to occupy ecologically similar terrain, suggests that they might once have formed a more continuous zone of vegetation over part or all of the plains. This possibility is raised by Lawson (1966), who proposes that such a widespread cover of forest and thicket might have been lost due to fire. Although Jeník and Hall (1976) consider that the importance of fire may be over-estimated, the suggestion remains unchallenged that woody vegetation, including dry forest, was once a more dominant feature on the Accra Plains (Aubréville 1950, Okali et al. 1973).

The dynamic relationships between the Capparion and Diospyrion alliances have not been explored; it is likely that an understanding of such relationships, along with information on climatic and anthropogenic factors, would contribute to an assessment of the history of forest development on the plains.

The study undertaken here deals principally with an isolated patch of dry forest in the western subscarp zone of

the Accra Plains, situated within a more typical thicket/grassland mosaic (approximate position, $5^{\circ}45'N$ $0^{\circ}08'W$). The forest, Pinkwae (frontispiece), is unique among forest patches in the area in that it has been undisturbed for the past 150 years; it therefore presents an opportunity to investigate some of the long-term dynamic processes of forest development and succession and to compare them with those seen in the nearby thicket/grassland formations.

Within the western subscarp area (Fig. 2), several large patches of woody vegetation occur; these range from closed-canopy forest to low, dense thicket. The clear overlay of the map shows that these patches are restricted to comparatively high ground (wooded areas north of Amrahia were not mapped). Further, the outline of the patches is strongly suggestive of active degradation of the vegetation along the wind-exposed southwest margins (see also Fig. 3).

A levelling transect through a large, partly degraded patch of thicket near Madina (Fig. 4) shows that the development of thicket vegetation is closely related to microtopography, with woody vegetation occurring on slightly elevated areas and absent from slightly lower areas.

Map of Pinkwae area. Contours drawn at 50-foot intervals. Clear overlay shows extent of woody vegetation patches (after 1961 aerial photographs, Hunting Surveys Ltd, produced for Ghana Geological Survey Dept). Broken lines indicate areas of discontinuous small thicket patches.

Figure 2

Map of Pinkose area. Contours drawn at 50-foot intervals. Clear overlay shows extent of woody vegetation patches (after 1961 aerial photographs, Hunting Surveys Ltd. produced for Ghana Geological Survey Dept). Broken lines indicate areas of discontinuous small thicket patches.

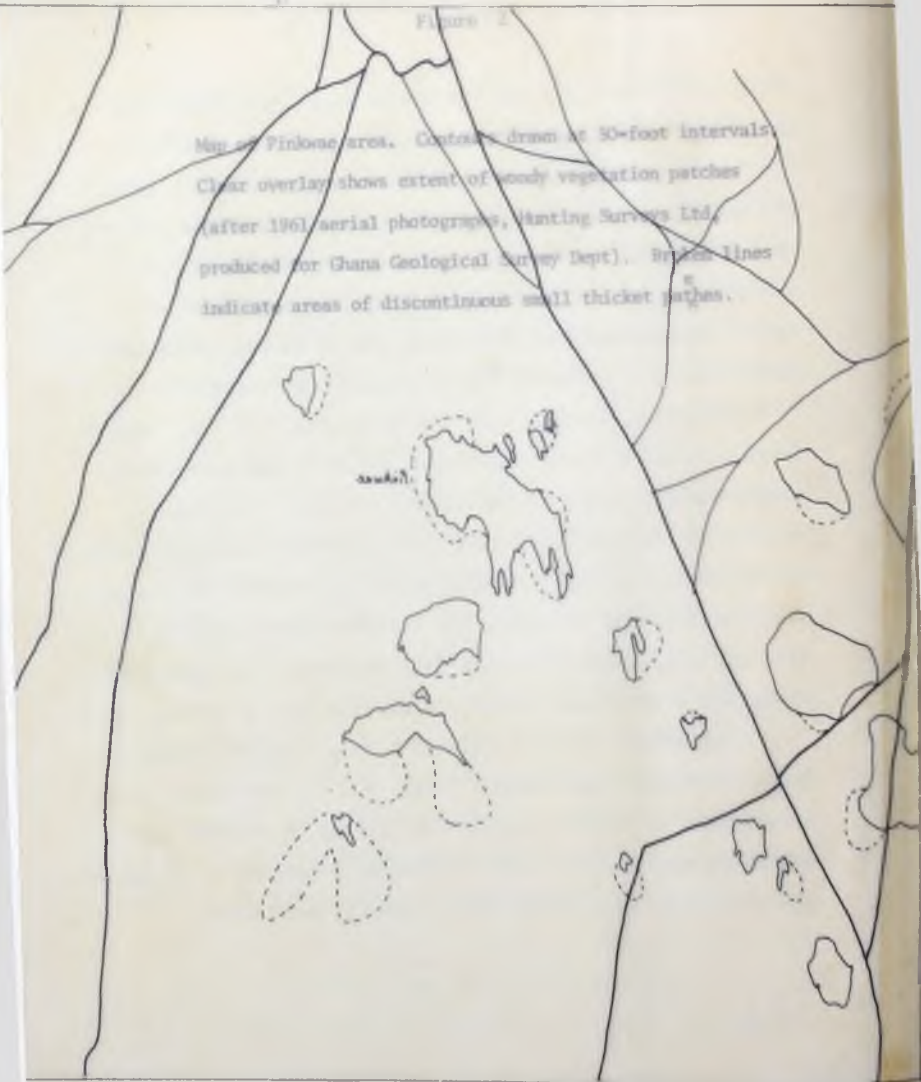

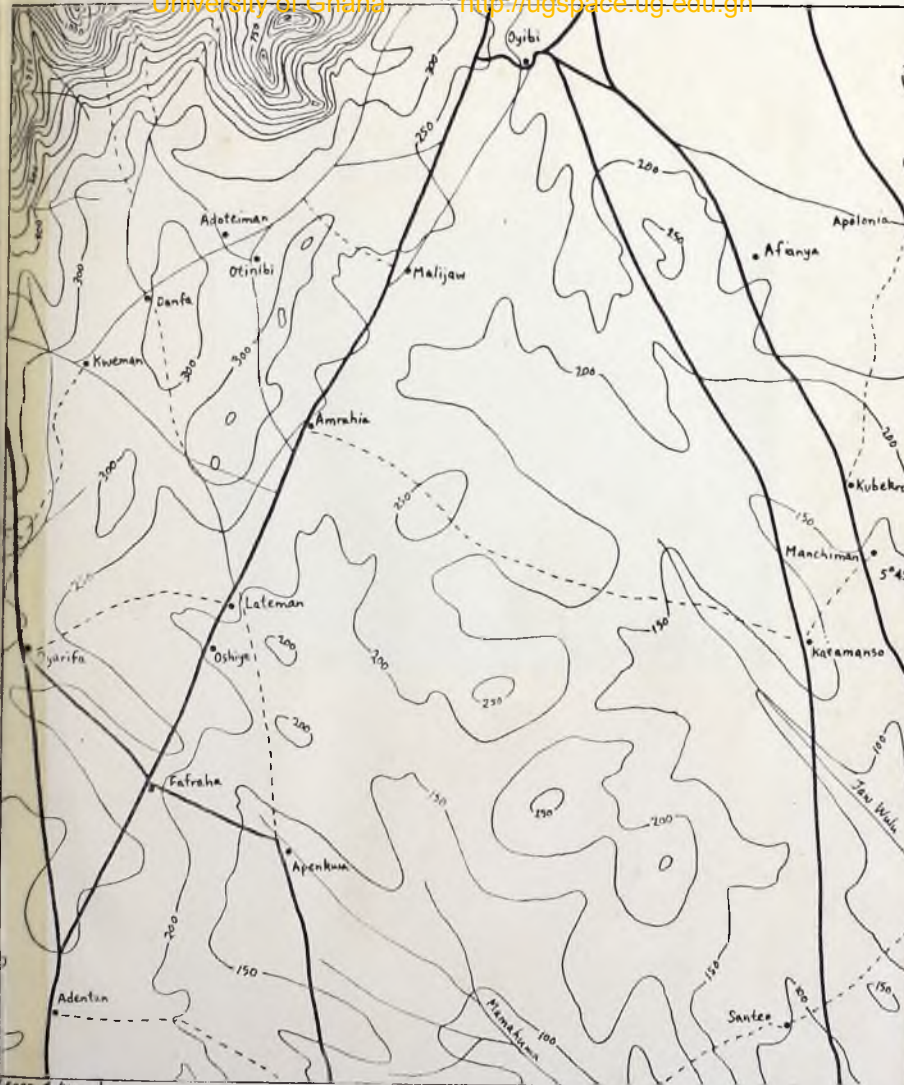

4 km
0°10'W

0°05'W

Figure 3

Aerial photograph of forest patch south of Pinkwae; disturbed areas visible within forest indicate clearings for farms. This forest patch has completely disappeared since the photograph was taken in 1961, due to farming.



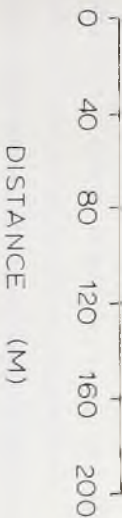

EL. ABOVE DATUM

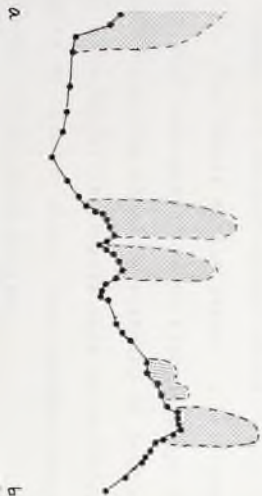
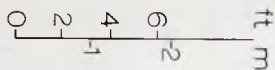

44

Pinkwae

Pinkwae, which is about 120 ha (1.2 km²) in area, covers the summit and part of the northern slope of a low hill (Fig. 5a). The wind-exposed southwestern margin is strongly indented, with narrow fingers of grassland penetrating into the forest margin. The sheltered northern and eastern margins are comparatively smooth in outline (Fig. 5b). The forest margin itself is very abrupt, the transition from open grassland to closed-canopy forest 4-8 m in height occurring within a distance of 5-10 m (Fig. 6). The border is largely made up of shrubby plants and banks of climber stems; this shrubby border tends to be wider along the southern margin.

The canopy of the forest itself is closed, and ranges in height from 3-5 m in areas of active re-growth to 6-10 m in established areas. Emergent trees commonly reach 12-14 m. Distinct strata do not occur, although for convenience one may distinguish between understory, lower canopy, upper canopy and emergent levels. Woody climbers are abundant and in some areas contribute significant amounts of the total basal area. With the exception of occasional tangles of climber stems, the forest is generally free of undergrowth. Several of the common species of

Levelling profile of a 580-m transect through Pinkwae; transect runs northwest-southeast from one margin of the forest to the other. Above: tree density (trees per 0.01 ha) in 20 m x 5 m plots along the transect; trees having breast height girth of 20 cm or more included. Forest is seen to extend further down the north slope than the south slope of the hill.

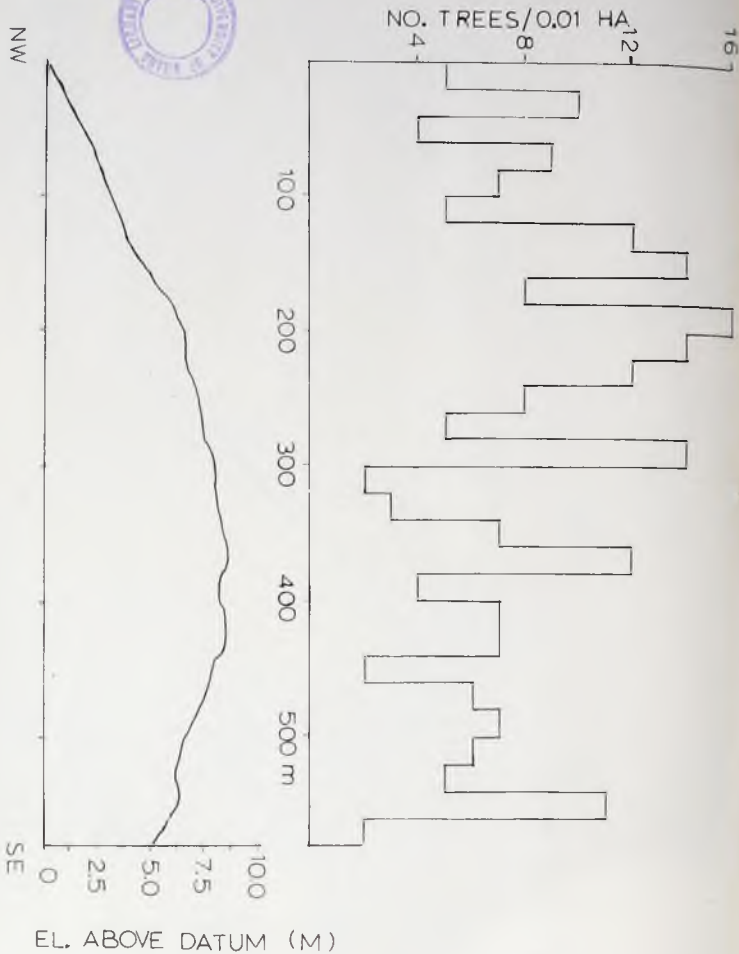
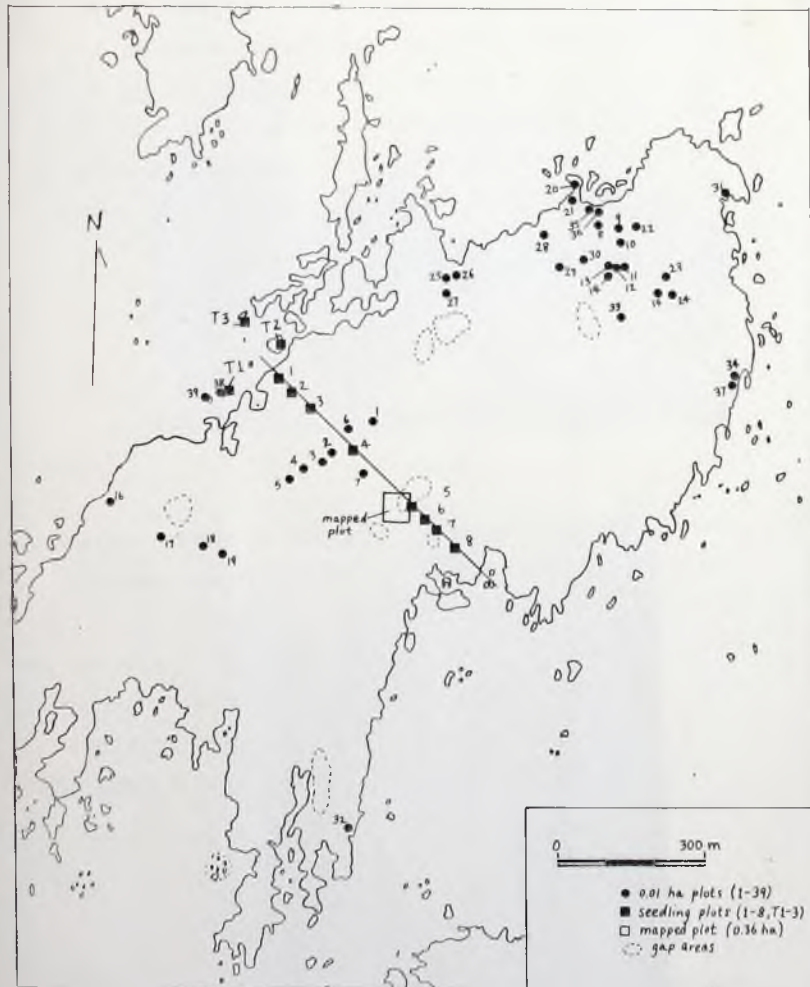

Figure 5 b

Map of Pinkwae showing sampling sites. Symbols explained in inset key. NW-SE transect across the centre of the forest indicated.



Margin of the forest, showing the very abrupt discontinuity of the vegetation. Marginal tree species include Antiaris africana (leafless) and a pair of Ceiba pentandra trees at the right. The height of the vegetation at the left is about 4 m. The grassland area has patches of Vetiveria fulvibarbis and is dotted with small termite mounds.

Figure 7

Base of large emergent Antiaris africana near the northern margin of the forest, showing the extent of a large surface root exposed by sheet erosion. A cutlass is placed against the trunk for scale. The protuberance near the base of the trunk suggests that this tree may once have been associated with a termite mound which has since disappeared. The surrounding plants are mainly shrubs of Securinega virosa and young trees of Zanthoxylum xanthoxyloides; a cut stump of Lannea acida may be seen to the right of the tree.



climbers bear thorns or spines (Capparis erythrocarpos,^a Canthium horizontale, Asparagus warneckei) and these can impede movement through the forest in some areas. The ground cover is predominantly made up of seedlings and root suckers of woody species, with occasional herbs (Elytraria lyrata, Hillieria latifolia) and sedges (Mariscus dubius). Shrubs are rare, and generally occur along paths or near gaps.

Based on floristic characters, Pinkwae is classified as a South-east Outlier forest (Hall and Swaine 1976), having affinities with patches of forest elsewhere on the western and sub-scarp Accra Plains. Most such patches occur on hilltops (Shai Hills, Krobo, Yogaga, and Osudoku). This forest type is the driest found in Ghana, and represents the limit, in terms of moisture, of forest development: drier areas do not support forest. A great many species occurring in Pinkwae are thus necessarily at the geographical and ecological limits of their range. This includes species which are common in dry forest but are absent from thicket vegetation, as well as species which are more abundant in the wetter forest types and occur only rarely in dry forest. Other species occur ^{both} in thicket and forest. Table 1 shows the ecological ranges of the

^a Nomenclature follows Hutchinson and Dalziel (1954-1972); authorities given in Appendix 1.

Table 1

Range of habitats in which species from the Pinkwae area are known to occur. Habitats are Evergreen forest (EF), Semi-deciduous forest (SDF), Dry forest (DF), Forest margins (M), Thicket clumps (TC), and Open grassland (G). Plus-sign indicates presence of species in the habitat; parentheses indicate rarity within the habitat. Table compiled in part using unpublished data from J. B. Hall and M. D. Swaine. Species ranked from predominantly wet-habitat to predominantly dry-habitat species.

SPECIES	HABITAT					
	EF	SDF	DF	M	TC	G
Trees						
<i>Baphia pubescens</i>	+	+	+	+		
<i>Dialium guineense</i>	(+)	+	+	+		
<i>Dichapetalum guineense</i>	(+)	+	+	+	+	
<i>Elaeophorbia drupifera</i>	(+)	(+)	+	+	+	
<i>Antiaris africana</i>		+	+	+	+	+
<i>Baphia nitida</i>	+	+	+	+	+	+
<i>Ceiba pentandra</i>	+	+	+	+	+	+
<i>Diospyros abyssinica</i>		+	+			
<i>Gardenia nitida</i>		(+)	(+)			
<i>Drypetes floribunda</i>		(+)	+	+		
<i>Lannea nigriflora</i>		+	+	+		

HABITAT

SPECIES	EF	SDF	DF	M	TC	G
<i>Diospyros mespiliformis</i>		+	+	+	+	+
<i>Chaetacme aristata</i>		(+)	+	+	+	
<i>Drypetes parvifolia</i>		(+)	+	+	(+)	
<i>Erythroxylum emarginatum</i>		(+)	+	+	(+)	
<i>Albizia glaberrima</i>		+	+	+	+	+
<i>Ochna membranacea</i>			+			
<i>Teclea verdoorniana</i>			+			
<i>Vepris heterophylla</i>			+			
<i>Afraegle paniculata</i>			+	+		
<i>Cassipourea congoensis</i>			+	+		
<i>Malacantha alnifolia</i>			+	+	+	
<i>Ehretia cymosa</i>			(+)	+	+	
<i>Flacourtia flavescens</i>			+	+	+	+
<i>Millettia thonningii</i>			+	+	+	+
<i>Zanthoxylum xanthoxyloides</i>			+	+	+	+
<i>Azadirachta indica</i>				+	+	+
<i>Clausena anisata</i>				+	+	+
<i>Lannea acida</i>						+
<i>Gardenia ternifolia</i>						+
Climbers						
<i>Calycobolus heudelotii</i>	(+)	+	+			
<i>Cremaspora triflora</i>	+	+	+			

HABITAT

SPECIES	EF	SDF	DF	M	TC	G
<i>Strychnos usambarensis</i>	+	+	+			
<i>Hippocratea africana</i>	(+)	+	+			
<i>Dracaena surculosa</i>	+	+	+	+		
<i>Canthium horizontale</i>	+	+	+	+	+	
<i>Griffonia simplicifolia</i>	+	+	+	+	+	
<i>Jasminum pauciflorum</i>	+	+	+	+	+	
<i>Secamone afzelii</i>	+	+	+	+	+	
<i>Acridocarpus smeathmannii</i>	+	+	+	+	+	+
<i>Alafia scandens</i>		+	+			
<i>Strophanthus hispidus</i>		+	+			
<i>Adenia lobata</i>		+	+	+		
<i>Grewia carpinifolia</i>		+	+	+	+	
<i>Asparagus warneckei</i>		(+)	+	+	+	
<i>Capparis erythrocarpos</i>		+	+	+	+	+
<i>Trielisia subcordata</i>		+	+	+	+	+
<i>Pleiocarpa pycnantha</i>			+			
<i>Rytigynia umbellulata</i>			+			
<i>Tiliacora funifera</i>			+			
<i>Triaspis odorata</i>			+			
<i>Grewia megalocarpa</i>			+	+		
<i>Ipomoea mauritiana</i>			+	+	+	
<i>Ritchiea reflexa</i>			+	+	+	
<i>Uvaria ovata</i>			+	+	+	

HABITAT

SPECIES	EF	SDF	DF	M	TC	G
Shrubs						
<i>Coffea ebracteolata</i>	+	+	+			
<i>Chassalia kolly</i>	+	+	+	+	+	
<i>Oxyanthus racemosus</i>		(+)	+			
<i>Turraea heterophylla</i>		+	+	+		
<i>Pavetta corymbosa</i>		(+)	+	+	+	
<i>Mallotus oppositifolius</i>		+	(+)	+	+	+
<i>Carissa edulis</i>			+	+	+	
<i>Allophylus spicatus</i>			(+)	+	+	
<i>Uvaria chamae</i>					+	+

predominant species in Pinkwae.

The most abundant tree species, contributing around 60% of adult trees and 70% of tree seedlings, is Drypetes parvifolia (Euphorbiaceae). A slender tree with a narrow crown, this species seldom exceeds 5-6 m in height or 18 cm in diameter. It is a major component of the middle and lower canopy throughout Pinkwae, in some patches approaching a pure stand. The tree readily produces coppice shoots. Saplings of the species are also very common. A second species in the genus, D. floribunda, is the next most abundant tree. This species is larger than D. parvifolia, having a more spreading crown, and attaining a maximum diameter of around 22-25 cm. D. floribunda is caulicarpous and has notably thin bark ^{cf.} (Taylor 1960).

Emergent trees (which may also contribute to the canopy) are mostly of three species. Diospyros abyssinica (Ebenaceae) occurs throughout Pinkwae and in some areas forms local patches of high density. This tree has very hard wood and a large, dense, spreading crown; old individuals commonly reach 12 m or more in height and diameters of 28-32 cm. The soil beneath large Diospyros abyssinica trees is typically blacker than elsewhere, and the density of seedlings and suckers beneath them is much depressed.

Lannea nigritana (Anacardiaceae) is a stout, spongy-barked tree with a spreading, feathery crown; the tree is completely bare from December-April. This species occurs in clones of high local density developed from root suckers. Young trees are conspicuously rare, these tending to occupy the edges of gaps or paths. The largest Lannea nigritana trees are usually 10-12 m in height and around 25-30 cm in diameter, although a few "giants" in the population have been recorded at over 35 cm.

Dialium guineense (Caesalpiniaceae) is a robust, straight-boled tree with a more-or-less spherical but sparse crown. It is widespread, but nowhere abundant, in Pinkwae. Large trees seldom exceed 12 m in height or 28 cm in diameter. The stems of this species are valued in the manufacture of pestles used to pound cassava and other tubers.

Less abundant emergents include Millettia thonningii, Afraegle paniculata, Antiaris africana, Diospyros mespiliformis and Ceiba pentandra, all of which are confined entirely or almost entirely to the forest margin.

Understorey and lower canopy species include Erythroxylum emarginatum (Erythroxylaceae), a slender shrubby treelet which rarely reaches 4 m in height; Dichapetalum guineense (Dichapetalaceae), a small, delicate-branched tree sometimes scrambling in form; Vepris heterophylla and Teclea

verdoorniana (Rutaceae), both small, robust trees with spreading crowns which occasionally reach canopy height; Ochna membranacea (Ochnaceae), a sparsely-branched slender tree with a narrow crown; and Chaetacme aristata (Ulmaceae), a stout, basally-branched, scrambling tree bearing thorns on its trunk (Fig. 8).

Most of the woody climbers belong to four species: Capparis erythrocarpos, Canthium horizontale, Uvaria ovata, and Grewia carpinifolia. Somewhat less abundant but by no means uncommon are Calycobolus heudelotii, Hippocratea africana, Tiliacora funifera, Griffonia simplicifolia, Strophanthus hispidus, and the non-woody species Dracaena surculosa. There are, in addition, a large number of rarer species.

Trees and climbers each contribute approximately 40% of species in the forest, with the remaining 20% being made up of herb and shrub species.

Notable within the forest are certain large gaps, lacking trees, and occupied by a dense cover up to 1.5 m in height of scrambling shrubs and woody climbers, predominantly Grewia carpinifolia, Uvaria ovata, Capparis erythrocarpos, and Carissa edulis (Fig. 9). The approximate positions of a few of these large gaps have been mapped (Fig. 5b). One such gap which was surveyed in some detail was found to occupy

Tree of Chaetacme aristata, showing profuse basal branching. Height indicated by metre rule. Shoots of the climber Strychnos usambarensis (acuminate leaves) in the foreground.

Figure 9

Large climber-filled gap in forest. Bare branches of Lannea nigriflora to the left, covered with climbers; bare trees in background also Lannea nigriflora.



a slight topographical depression. While their origin is not known, their very large size (up to 0.5 ha in area) would seem to preclude the possibility that they have resulted from tree-falls, even multiple tree-falls of individuals joined together by climbers. Alternatively, they could be caused by soil zones which are for some reason poorly suited to normal woody plant growth, or be anthropogenic in origin (being the remains of old farms within the forest). Smaller gaps, resulting from tree falls, do occur as well.

The soil under the forest as a whole is distinctly patchy, varying from pale brown, fine soil lacking stones (often near the margins or in large gaps), to dark reddish soil with numerous tiny stones below the topsoil layer (over most of the summit) (Fig. 10), to black, coarse soil (typically found under stands of Diospyros abyssinica). The stone-free topsoil layer is generally 10-15 cm in depth. Large blocks of laterite break the soil surface in some areas. The shift from one kind of soil patch to another is often quite abrupt.

Termite mounds (Fig. 11) occur commonly (on the order of 20-25 ha⁻¹) in Pinkwae. The majority of these are rather eroded in appearance, although some are as much as two metres in height and four or more metres in basal

Soil pit under closed canopy forest near the summit of the hill. Soil is reddish in colour, with numerous small stones below the topsoil layer; topsoil approximately 15 cm deep. Root suckers of the climber Calycobolus heudelotii on the soil surface to the left of the metre rule.

Figure 11

Old eroded termite mound inside forest. Small tree of Drypetes floribunda growing near base, with a large, woody climber, Grewia carpinifolia, immediately to the right of it (note flowering cushions on Drypetes floribunda stems). Burrow excavated by animal just behind the tree. Small coppicing tree of Drypetes parvifolia at top of mound.



diameter. Termite activity in the soil is quite conspicuous at times, and may result in the burial or uprooting of large numbers of seedlings. Where mounds occur in the blackish-soil patches in Pinkwae, such as those associated with Diospyros abyssinica, the soil colour of the mounds is consistently redder than the surrounding surface soil; this would suggest that the soil patches observed are strictly surface phenomena overlying a generally uniform reddish sublayer.

The forest is surrounded by broken-up areas of thicket. At greater distances from the forest margin, these thickets tend to be smaller in size and of the more usual wind-exposed thicket clump shape, while near the margin (particularly along the northern edge), the thickets are irregular in shape and often rather large - as much as 0.25-0.50 ha (see Fig. 5b).

Thicket patches, whether near the forest margin or farther away, differ from the forest in both stature and species composition. The thickets have a low canopy (2-4 m or sometimes more) with one or a few emergent trees towering above at 10-14 m. This vegetation is largely impenetrable due to the thick tangle of shrubs and climbers, many of them spiny (Flacourtia flavescens, Carissa edulis, Capparis erythrocarpos), which skirt the thicket, and the rather dense

undergrowth of fallen climber stems, thorny shrubs, and tree saplings within. Like thicket clumps elsewhere on the Accra Plains, many of these thicket patches are associated with termite mounds.

Thicket areas near the forest are usually dominated by emergent trees of Antiaris africana (Fig. 7), Millettia thonningii, Albizia glaberrima or Zanthoxylum xanthoxyloides, all of which occur in Pinkwae only at the forest margin. Occasionally, forest trees (Lannea nigritana, Vepris heterophylla, or Drypetes floribunda, for example) are found in these patches. Farther away from the forest, the clumps are dominated by Antiaris africana, Zanthoxylum xanthoxyloides, Elaeophorbia drupifera, Adansonia digitata, Ficus capensis, and Kigelia africana; the latter three of these never occur in Pinkwae, and Elaeophorbia drupifera has been recorded only once from the forest.

The intervening areas between thickets bear grassland containing the grasses Vetiveria fulvibarbis, Heteropogon contortus, Panicum maximum, and Sporobolus pyramidalis (among others); the sedge Fimbristylis sp; and a large number of small forbs, notably Cassia mimosoides, C. rotundifolia, Phyllanthus sublanatus, Borreria scabra, and Tephrosia elegans. Shrubs which typically occur in open grassland include

Securinega virosa, Capparis spp., and Dichrostachys cinerea, the latter species favouring disturbed ground such as areas of cattle trampling. Trees which are characteristic of open grassland in the Pinkwae area are Lannea acida (Fig. 12), Gardenia ternifolia (Fig. 13), Lonchocarpus cyanescens, and Maytenus senegalensis. Millettia thonningii, Baphia nitida and Flacourtia flavescens are tree species of the forest and thicket which occur only as shrubs in open grassland.^a

Termite mounds, of a smaller size and more dome-like form than those of the forest and thicket, occur in the open grassland. Some open areas have developed a hard-pan soil which is almost entirely bare of vegetation; these are generally on some of the slopes and summit areas, outside the forest, and between thicket patches.

Although a complete inventory of animal species in the Pinkwae area is beyond the scope of this study, records were kept of animals observed on visits to the study area; a list of vertebrate species thus recorded is given in Appendix 2.

^aThe habit of a species may vary over its geographical range; where habit is indicated in the text, it pertains to that occurring at Pinkwae.

Banded tree of Lannea acida showing full crown of recently expanded leaves. This species occurs in open grassland, and is here surrounded by the grass Vetiveria fulvibarbis in the neighbourhood of small, low thickets.

Figure 13

Leafless tree of Gardenia ternifolia in open area near the northern margin of the forest. The soil is an eroded hard-pan except directly below the tree, and grass is mostly lacking. Note undecomposed leaf litter. Height indicated by metre rule. A very small coppicing plant of Millettia thonningii, which had been felled at the base, is in the left foreground.



History

Pinkwae and the lands surrounding the forest belong to the village of Katamanso (a Ga village subject to Nungua, Greater Accra Region), which lies about three kilometres to the east of the forest. Now a small farming and cattle-herding settlement of about 340 people (Census Office 1972), the village was once a link in the salt trade which connected the coastal Ga towns with Akan towns farther inland.

Katamanso achieved its greatest prominence during the Ga-Ashanti War, as the site of a pivotal Ga victory. The Battle of Katamanso (sometimes called the Battle of Dodowa after a larger town to the north) took place in 1826 at a time when the Ga and their British allies had been sustaining heavy losses and were in danger of defeat (Reindorf 1889).

The events of the battle itself were recounted to me as follows by the chief of Katamanso, Nii Laryea Akuete VIII, in the company of some of the village elders. The battle began with a surprise attack shortly after dawn by the Ashanti; some Ga women who had gone out to fetch water saw in the distance a large encampment of Ashanti soldiers, and hurried back to warn the village. The ensuing attack left a great many Ga soldiers dead, as well as the Ga linguist;

the pond from which the women were to have brought water was red with blood and remained so for a long time thereafter. Fighting raged for several days, with severe losses on both sides. The battle lines stretched over a distance of two miles, much of the fighting taking place in the forest itself. (It is said that heavy rains still occasionally wash to the soil surface pieces of shot from the battle.) At last the Katamanso chief implored the gods to deliver victory for his people, vowing in return to protect the forest from all future harm. The Ga soldiers, aided by British soldiers armed with rockets, then routed the Ashanti, who fled through the forest, many of them dying on the way. For about a year after the battle, the Katamanso soldiers lived in semi-permanent camps within the forest, in anticipation of a return attack by the Ashanti. During this time, the men never left the forest, but were brought food by women from the village, who tended small farms near the forest. Large pitfalls were dug, which were covered with branches and set about with nooses, and alarm systems were devised within the forest to warn of an impending attack. The remains of pottery and what appear to be old building mounds dating from this period may still be seen in the forest. The Ashanti did not, in the end, return, and peace was made sometime later.

After the battle, the forest was given its present name, "Pinkwae", which means "move to the forest"; this was the cry raised by the retreating Ashanti soldiers, and the name of the forest thus commemorates the victory. The forest had previously been called "Kohag", translated roughly as "clear forest" or "open forest".

As a result of the events of the Battle of Katamanso 150 years ago, all cutting of wood within Pinkwae is forbidden by traditional authority. The preservation of the forest is taken by every chief of Katamanso as a sacred duty, and the villagers uphold the policy with some fervour.

Utilisation

Although the religious importance of Pinkwae was augmented because of the battle, the forest had previously been a sacred grove. There were shrines in it, as there are now, especially to a god (Afiye) who could be consulted in periods of major difficulty, such as drought or famine. Pinkwae was also the source of the sacred bushbuck which were captured each year for the Nungua deer festival. This festival was permanently discontinued at the time of the battle.

In earlier times, poles of Drypetes parvifolia were sometimes cut for roofing, and Diospyros abyssinica was used for house frameworks. Now all cutting of wood is strictly

prohibited, whether for timber, firewood, charcoal-making, or clearing of land for farming. (The chief recalled several alarming stories concerning the fate of people who had ignored this injunction.) It is, however, permissible to cut sticks for basket weaving, or to collect plants for medicinal purposes.

Hunting is presently done year-round in Pinkwae except during the antelope mating season (August-September). Game is plentiful, and the principal species sought for food include bushbuck (Tragelaphus scriptus scriptus), black duiker (Cephalophus niger), green monkeys (Cercopithecus aethiops tantalus), Togo hare (Lepus capensis zechi), and many kinds of bush fowl. Hunting is done mainly by villagers from Katamanso, who use snares, 12-gauge shotguns, and rifles, as well as antique flintlock weapons. Hunting is generally done around dawn and dusk for birds and monkeys, and at night, with carbide lamps, for antelope. Despite the fact that hunting is popular and bush meat is highly favoured, the amount of game killed seems to be limited, at least in part, by chronic shortages of ammunition. The villagers also express a commitment to the conservation of game in Pinkwae.

The lands surrounding the forest, like much of the Accra Plains, are used intensively for farming, grazing of

cattle, and wood-cutting. Farming is usually done on the grassland between thicket clumps, although thicket is sometimes cleared for farming. The land is cultivated by hand or with tractor-drawn ploughs and planted with cassava and maize. Large-scale mechanised farming has recently been introduced in the area south of the forest (between Fafraha-Oshiye and the University of Ghana Agricultural Research Station at Nungua), with extensive clearing of all wooded land. The grasslands are burned from time to time by farmers and cattle-herders, some areas being burned annually, but most being burned less often.

Wood is cut in very large amounts for firewood and charcoal-making. Preferred species are Zanthoxylum xanthoxyloides, Antiaris africana, and Azadirachta indica, although a great many other species (Millettia thonningii, Malacantha alnifolia, Lannea acida, Albizia glaberrima, and Ximenea americana for example) are used occasionally. These species all grow within thicket clumps or in the open grassland between clumps. The demand for firewood has risen dramatically with the rising population of the Accra area, and many of the thicket clumps have been virtually clear-felled. All the large wooded areas in the vicinity of Pinkwae, such as those near Oyarifa, Fafraha, and

Lateman (see Figure 2) have been used heavily for wood-cutting and are now reduced to patches of short dense thicket. Despite severe warnings from Katamanso, residents of some of the villages on the north side of Pinkwae, particularly Amrahia, have recently begun to make forays into the forest itself for firewood. At present, most of this cutting is restricted to the forest margin.

SEASONALITY AND PHENOLOGY

Introduction

Seasonality

Seasonality of the environment exposes plants to regular, periodic changes in the quality and abundance of resources. Secondly, seasonality causes fluctuations in resources and stresses imposed by other organisms, including pollinators, seed dispersal agents, competitors, and predators (Snow 1965, Janzen 1967, Gibbs and Leston 1970, Malaisse et al. 1975). To the extent that they are better able to utilize resources and avoid predation, organisms which perceive and respond appropriately to seasonal changes should have a selective advantage over those which do not. Temperate seasonal fluctuations are often stringent enough to impose physiological limitations on the behaviour of both plants and animals; this is often not the case in wet tropical climates (Richards 1952, Walter 1971, Daubenmire 1972). The problem, on an evolutionary level, is thus for the plant to respond to what may be slight or physiologically unimportant environmental changes. Seasonally dry tropical climates, such as that found on the Accra Plains, differ from wet tropical climates in that a

part of the year may, due to moisture stress, be physiologically unsuitable for plant growth; animals in such climates may or may not be so constrained.

In the tropics, seasonal variation occurs in temperature, humidity, rainfall, wind speed, and daylength, and all of these factors are known, alone or in combination, to play a role in triggering phenological changes in tropical plants (Longman and Jeník 1974). These factors differ from one another in both uniformity (range) and regularity of pattern. Tropical temperatures tend to be high, and diurnal variation may be greater than seasonal variation (Janzen 1967, Longman and Jeník 1974).

Rainfall patterns vary greatly from one area to another in the tropics. Between 3° and 10° latitude, the annual rainfall pattern is bimodal, and the two wet seasons are often unequal in length. Where the rainfall is seasonal or irregular, as in southeastern Ghana, the total amount of rainfall tends to be lower.

Tropical daylength changes are small in magnitude, but are reliable from year to year.

Flowering and Fruiting

The enormous literature dealing with flowering and fruiting in the tropics attests to the extreme complexity

of reproductive patterns. The use of different criteria in assessing phenological condition has added some confusion as well. Frankie et al. (1974^a), for example, base their conclusions on observations of "peak" flowering activity, while Croat (1969) used presence-absence records obtained from herbarium specimens. Different authors have attempted to assess the phenological condition of populations (Taylor 1960), individual trees (Daubenmire 1972), or individual shoots (Hopkins 1970). There are obviously advantages and disadvantages to all these approaches; ideally, one would like to have information on all three levels (populations, individuals, and shoots), so that variability within each could be quantified (Frankie et al. 1974 b).

It is usual for some flowering to take place year-round in tropical forests. The seasonality of flowering is more marked in seasonally dry forests. Seasonality of flowering is greater in the canopy than in the understorey (Richards 1952, Frankie 1975), probably due to greater microclimatic variation.

A major flowering peak has been found in some areas to occur during, or at the end of, the dry season: wet forests of Java, Ceylon, Ivory Coast, and British Guiana (Richards 1952), Queensland and Surinam (Whitmore 1975),

and Central America (Frankie 1975) follow this pattern, as do semi-deciduous forests of Ceylon (Koelmeyer 1960) and Central America (Janzen 1967, Daubenmire 1972, Frankie 1975). Daubenmire noted that flowering in his study was not inhibited by even severe drought.

Exceptions to this pattern have been reported. Whitmore (1975) states that flowering in rainforest in the Solomon Islands has no discernible peaks. Wet season peaks in flowering have been observed in rainforests of Nigeria (Richards 1952), Malaya (Medway 1972), and New Hebrides (Baker and Baker 1936).

Croat (1969) found, in semi-deciduous forest in Panama, that roughly equal numbers of species flowered in the wet season and the dry season, but when the species were classified according to life-form, family, and seed-dispersal method, certain patterns emerged. Dry-season flowering was principally found in large trees, vines, and some shrubs, while wet-season flowering was typical of shrubs, herbs, and small trees. Some families flowered mainly in the dry season, while wet-season flowering was characteristic of other families; a few families had several members flowering throughout the year. Species with wind-dispersed seeds tended to flower in the dry season.

Croat points out that even in those species with recognisable peaks in flower production, flowering was protracted (40% of such species flowered continuously over a nine-month period). Flowering activity was least at the start of the wet season.

Flowering pattern varies from one species to the next. Corner (1940) distinguishes between ever-flowering species, in which reproduction is continuous, and intermittently flowering species. Ever-flowering species may produce flowers and fruit simultaneously, or successively at short intervals. Many start flowering at an early age and flower continuously thereafter; these include mostly the smaller woody species (Richards 1952), secondary species, forest margin species, and montane forest species (Whitmore 1975). Intermittently flowering species commonly begin flowering when much older; they include mostly large trees.

Most tropical forest species flower at relatively regular intervals (Longman and Jenik 1974). Annual flowering is common. Other species flower two or more times per year, while some do so at periods greater than a year.

As in leaf production and fall, flowering may be asynchronous within an individual plant, some branches bearing flowers and fruits and others not.

Flowering may be synchronised to a greater or lesser degree within a population. Synchronous, or gregarious, flowering is not uncommon; examples include many dipterocarps (Whitmore 1975), the Myrtaceae (Richards 1952), species of Coffea (Corner 1940), and certain orchids (Walter 1971). Species with a very short flowering period often show gregarious flowering behaviour (Walter 1971), and this is clearly related to maximizing outcrossing.

Extended flowering, in which a few flowers are produced each day over long periods, is typical of many understory species, especially in wet forests. Such behaviour is seldom found in canopy species (Frankie et al. 1976).

The length of time required for maturation of fruit varies from species to species, so that flowering seasons may differ between species while their fruiting season is the same (Richards 1952). Based on records from 22 semi-deciduous forest species, Daubenmire (1972) found the mean elapsed time from pollination to dissemination to be 3.5 months.

Evolution of flowering and fruiting season may be related to enhancement of seed dispersal and protection from seed predation. Competition for seed dispersal agents (frugivorous birds) is considered to be responsible for the

observed displacement of fruiting seasons in several sympatric species of Miconia in a tropical American forest (Snow 1965). In drier forests, production of fleshy fruits in the dry season may encourage dispersal by frugivorous mammals, which rely on the moisture of the fruit at that time of year (Janzen 1967, Frankie et al. 1974^a). Species with wind-dispersed seeds often fruit at the end of the dry season, a time when gusty winds are common.

Fruiting just before the wet season may provide the best opportunity for germination of seedlings and escape from seed predation (Richards 1952, Daubenmire 1972).

McKey (1975) notes that species whose fruits are exploited by specialized frugivores often have extended fruiting seasons, while those dispersed by a variety of opportunistic species tend to have a short fruiting period; the latter group may have a mass-ripening crop which can attract large numbers of dispersal agents over some distance.

Large-seeded species are most susceptible to seed predation; smaller seeds lack the stored reserves which are attractive to rodents, and may be too small to accommodate developing insect larvae. Smythe (1970) found that large-seeded species tended to flower and fruit synchronously, thereby swamping the predator population (agoutis). When the predators were satiated, they scatter-hoarded the remainder of the seed crop, and this was largely forgotten about

and subsequently left alone.

The two- to six-year lag from one flowering period to the next in some synchronously flowering dipterocarps may be important in preventing the build-up of a reservoir population of seed predators; this is also probably important in synchronously-flowering monocarpic bamboos (Richards 1952, Janzen 1967).

Exogenous control over flowering has been established in many tropical species. The required stimulus may be a sudden (though slight) drop in temperature, such as that which often accompanies a rainstorm (Coster 1926, quoted in Richards 1952); in some species, a series of several cool days may have the same effect (Whitmore 1975). The longer the delay in the stimulus after the buds have formed, the lower will be the threshold level of the stimulus for flowering to occur; indeed, if the stimulus is delayed long enough after bud formation, the flowers open spontaneously (Richards 1952, Whitmore 1975).

Burgess (1972) observed that gregarious flowering in dipterocarps is induced by drought periods occurring three to five months beforehand. Daubenmire (1972) reached the same conclusion in Costa Rica. In Ceylon, flowering follows periods of low rainfall and /or low humidity in both wet and seasonally dry forests (Koelmeyer 1960).

The onset of flowering may be controlled by slight changes in air or soil humidity, or slight temperature fluctuations; this would explain the more obvious seasonality of flowering in canopy species, where the microclimate is less constant with time (Frankie 1975).

Some species are induced to flower by short or long day-lengths (Vaartaja 1959, Barua 1969); the photoperiod is perceived by the leaves (Wilkins 1969).

Janzen (1976) has presented compelling evidence that the control of flower production in the synchronously-flowering monocarpic bamboos must be entirely endogenous, possibly by the gradual accumulation of a temperature-insensitive, photo-sensitive substance which would function by counting days. Endogenous control seems also to be the case in the asynchronous monocarpic tropical American tree, Tachigalia versicolor (Foster 1977). Whitmore (1975) notes that species which produce flowers on some branches and not others must be responding to endogenous rhythms which are highly localized within the individual.

Foliage behaviour

Tropical forest trees exhibit a variety of patterns in leaf phenology. As there is much overlap in behaviour between different species, categorizations are difficult to make and tend to be arbitrary (Koriba 1958). One problem has

been establishing a meaningful criterion for deciduousness. Richards (1952) favours classifying as deciduous those trees which become bare or nearly bare, if only for a few days, and as evergreen those trees which always have a substantial cover of leaves. Other criteria have been suggested, but that of Richards has the practical advantage of ease of determination in the field.

Whitmore (1975) makes use of Koriba's (1958) classification of leaf growth patterns: (1) evergrowing - with continuous production and fall of leaves; Richards (1952) comments that few tropical trees renew their leaves at a constant rate, although a few examples are known from Medway's (1972) work on Malayan dipterocarp forest; (2) manifold - with different branches of the same tree appearing to behave independently of one another; examples are well known and include the silk cotton tree, Ceiba pentandra, and the mango; (3) intermittent - with a periodic pattern of leaf production and fall, but with the tree always having a cover of leaves; this pattern is considered to be the most prevalent among tropical trees (Richards 1952, Whitmore 1975); (4) deciduous - old leaves being shed before expansion of new leaves; this is most common in the drier, more seasonal forests.

Flushing, or the synchronous production of a new leaf crop, is characteristic of many tropical species, and may

occur at regular or irregular intervals (Fig. 14). Regular periods of one year or six months are common. Regular non-annual cycles are known as well: Holttum (1938) found cultivated individuals of Delonix regia in Singapore to flush every nine months, and Heritiera macrophylla to flush every thirty months; the behaviour of planted trees may, of course, differ from that of trees in natural communities.

In some species, for example Albizia falcata, foliar periodicity is known to occur in older trees but not in younger ones (Richards 1952). This contrasts with the findings of Njoku (1964) that periodic leaf production cycles are apparent even in the first year of growth in some Nigerian dry forest species.

While the leaf production pattern of individual species may be highly seasonal, a tropical forest may, as an entity, have little or no apparent overall pattern of leaf phenology. Daubenmire (1972), in his study of Costa Rican semi-deciduous forest, observed that some flushing occurred year-round, except for a period of one month during the major dry season. Similarly, Medway (1972) found flushing to occur in some species at all times of the year in Malayan forest. In general, greater climatic seasonality seems to produce greater synchrony in flushing between species.

Figure 14

Shoot of the tree Zanthoxylum xanthoxyloides showing new leaf flushes. This species appears to be rich in defensive chemicals, and the leaves are not attacked by herbivorous insects.



Several workers have reported that flushing increases towards the end of the major dry season, just prior to the onset of rains. Daubenmire (1972) found that 70% of species in his study were flushing about a month before the rains. Medway (1972) observed a noticeable peak in leaf production just after the driest time of the year, with a lesser peak taking place just before the major wet season. Exceptions to this pattern are known: leaf production reaches a peak at the wettest time of the year in Sarawak (Fogden 1972), and in many dipterocarp forest species, flushing occurs just at the start of the wet season (Fox 1972). These climates tend to be more non-seasonal than most.

Flushing leaves frequently have striking colours, including white, pale green, pink, red, purple, and blue; these colours are lost as the leaf matures. The ecological significance of the flush colours is not known (Longman & Jeník 1974, Whitmore 1975), although Taylor (1960) observed that red flushing appears to be common in species associated with damp soil conditions. The colours may be caused by the presence of anthocyanins (Longman and Jeník 1974), which are metabolic precursors of tannins (P. Waterman, pers. comm.)

Flushing (synchronous leaf production) itself is considered to be an important means of predator escape: the sudden appearance of a large food supply swamps the extant

herbivore population (insects), and by the time the population climbs in response to the food supply, the leaves will have hardened somewhat and may be protected chemically by that time as well (McKey 1974). That newly flushed leaves are indeed vulnerable to predation has been well-documented (McKey 1974, Malaisse et al. 1975). In contrast, species which do not produce leaves in synchronous flushes tend to maintain the highest levels of their defence compounds in young tissues (McKey 1974).

Leaf senescence and fall, like flushing, is more clearly periodic in more seasonal climates. In localities having a distinct dry season, leaf fall is found to be greatest at that time, and the extent of leaf drop is correlated with the intensity of moisture stress. Evidence for this comes from many parts of the world, including Trinidad (Beard 1944), Costa Rica (Daubenmire 1972, Frankie et al. 1974^A), Panama (Haines and Foster 1977), Ghana (Taylor 1960, Swaine, Hall, Lieberman and Dakubu, unpublished), and Nigeria (Hopkins 1966).

There is general agreement that the adaptive significance of deciduousness in seasonal tropical climates is the reduction of water loss from transpiration (Longman and Jeník 1974). Koelmeyer (1960) found that maximum leaf fall in a Ceylonese forest occurred when evaporation exceeded precipitation and

plants were dependent upon soil moisture reserves. Deciduous trees are increasingly predominant, in both species and individuals, in seasonally drier forests; indeed, the relative importance of deciduous trees has been a major criterion in the classification of tropical forests (Richards 1952, Taylor 1960, Walter 1971).

In moist and wet tropical forests, the deciduous trees are almost exclusively upper canopy trees, where desiccating winds and high temperatures are most likely to bring about moisture stress. Among some upper canopy deciduous species, saplings in the understorey are evergreen (Whitmore 1975).

Beard (1946) distinguishes between obligate and facultative deciduousness in forest trees in Trinidad. Facultative trees show a greater correspondence between moisture stress and the extent of leaf fall from year to year. Such trees are most common in moist and wet forests. Obligate deciduous trees are usually confined to seasonally dry forests. Koriba (1958) and Richards (1952) found certain species to be evergreen in non-seasonal areas and deciduous in drier, more seasonal climates. This plasticity in phenological behaviour highlights the problems pervading early discussions of tropical phenology, many of which were based on data from individual, planted specimens, often growing some distance from the nearest natural population.

The relative importance of endogenous and exogenous factors in triggering leaf production and fall has been argued at length. Richards (1952) considers that internal factors play a large part in periodic behaviour of tropical trees; he states that external factors, particularly water supply are probably influential as cues, but since conditions never compel the plant to rest - as does freezing weather in temperate regions - then internal factors can "have free play"; this is unlikely to be the case in seasonal climates, however. Whitmore (1975) finds that even in non-seasonal tropical climates leaf fall and flushing are commonly related to water stress, but that the relationship may be complicated by endogenous rhythms.

Other external factors besides drought may trigger leaf changes. Walter (1971) attributes pre-rain flushing to rising air temperatures, using examples from Panama, northern Australia, and south-west Africa. Flushing in miombo vegetation, also occurring prior to the onset of rains, is induced by warming of the soil during the dry season (Malaisse et al. 1975). Madge (1966) has suggested a connection between temperature fluctuations and leaf fall in a Nigerian forest.

Both Richards (1952) and Walter (1971) emphasize the importance of daylength as an environmental cue in the tropics, particularly where rainfall and temperature are essentially

non-seasonal. Tropical plants are known to be sensitive to very small changes in daylength (Longman and Jeník 1974). Njoku (1964) demonstrated that leaf production in Hildegardia barteri was related to daylength, with bud dormancy induced in 11.5-hour days and broken in 12.5-hour days. Lawton and Akpan (1968) have shown the importance of daylength in controlling leaf production in Plumeria at a latitude of only 7° . Daubenmire (1972) considers that daylength changes were the most likely trigger for flushing in his study area, while leaf senescence and abscission were probably in response to drought.

Wind may play a role in the timing of leaf fall, if only in effecting the removal of leaves which are already senescent (Addicott and ^{Lynch} A 1955). Hopkins (1966) makes the point that as leaf fall is the last stage in a complex series of developmental events, it probably cannot be linked satisfactorily to a single external governing factor. He also considers endogenous rhythms to be important in foliage changes.

Flowering and leafing patterns are not independent of one another. Species with continuous leaf growth tend to be ever-flowering, while those which flush at intermittent intervals tend to flower in the same way (Richards 1952).

It appears to be most common for species to flower and/or fruit when they are bare or nearly so (Richards 1952, Taylor 1960, Daubenmire 1972, Haines and Foster 1977). This may be related to the attraction of pollinators and seed dispersal agents (Haines and Foster 1977). Wind-dispersed species, as mentioned earlier, also fruit in the dry season when they are leafless. Many deciduous species of the wet forest do not begin shedding their leaves until they have become sexually mature (Taylor 1960, Hopkins 1970).

In individual trees, flowering may precede flushing by one to six months (Daubenmire 1972), although in some trees flowers and leaves appear together. The separation of reproductive and vegetative activity has been explained as involving an internal competition for metabolites or hormones (Alvim 1964); an opposing view is held by Janzen (1967) and Daubenmire (1972), who state that dry season flowering is advantageous because rapid vegetative growth at the start of the rains is essential if the plant is not to be overwhelmed by other nearby plants. Richards (1952) doubts the importance of internal competition, but feels that flowering and flushing are independent of one another and are in response to different stimuli.

Cambial Growth

Cambial activity patterns in tropical trees are little known (Pannier 1975), but may be related to a number of factors;

this has brought about the proverbial difficulty of assessing tropical tree age by means of growth rings. Growth rings occur, for example, in miombo trees, but are not annual, reflecting dry season flushing, fires, and defoliation by caterpillars (Malaisse et al. 1975). In many tropical species, rings are lacking altogether.

Woody growth is largely dependent upon leaf condition. Richards (1952) states that deciduous species, such as Terminalia catappa and Ficus variegata, cease cambial activity when leafless; this interruption may start when the leaves begin to change colour prior to falling. Evergreen species, such as Ficus annulata var. valida, cease cambial activity briefly just before flushing.

In seasonal tropical climates, trees show the greatest cambial activity during the wettest time of the year, when the tree (usually) has a full crown and growth conditions are optimum (Alvim 1964, Hopkins 1970, Daubenmire 1972).

Many tree species show some degree of radial shrinkage during the dry season, some showing a net loss of girth over the year if dry season shrinkage is severe (Dawkins 1956, Hopkins 1970, Daubenmire 1972). Maximum shrinkage occurs when trees flush at the end of the dry season, as the young, uncutinized leaves lose water readily. Complete loss of leaves does not prevent shrinkage, however (Daubenmire 1972). Shrinkage of this sort, due to moisture stress,

occurs as well in temperate trees (Kozlowski 1971).

It has been generally found that tree growth in tropical forests is correlated with moisture levels (Dawkins 1956, Alvim 1964, Hopkins 1965, 1970), but the relationship is not thought to be causal (Njoku 1963, Alvim 1964, Hopkins 1970). Physiological studies indicate that the immediate stimulus for cambial activity is the translocation of auxin produced in the expanding buds to the cambium (Wareing et al. 1964); mature leaves may produce enough auxin to maintain the cambium in an active condition, but senescent leaves do not (Longman and Jeník 1974). This is consistent with the field observation that the cambium is dormant in leafless trees. An exception is found in trees which flower while leafless, as flower buds and young fruits can provide sufficient auxin to stimulate cambial activity (Longman and Jeník 1974). It has been suggested (Lowe 1968) that cambial activity is related to daylength changes; if leaf behaviour is related to daylength changes, then this secondary relationship would be expected. Hopkins (1970) proposes that daylength changes initiate growth, with moisture exerting a limiting effect.

Methods

Information has been collected on rainfall, temperature and daylength for the study area.

Rain gauges were set up near the forest margin, in areas free from overhanging vegetation. There were initially two pairs of gauges, one on the north margin and one on the south margin; after the first few months, the southern pair of gauges disappeared, and records were collected thereafter from the remaining pair only. While both pairs were in operation, the agreement between them was good, with neither pair showing consistently higher or lower rainfall. Rainfall was assessed from these gauges at four-week intervals between September 1976 and March 1979. A small quantity of engine oil was added to the collecting bottles at the start of each collecting period in order to prevent evaporation of water from the bottles during the four-week interval.

Daily rainfall figures were obtained as well from the Amrahia Dairy Farm, located approximately 2 km north of the Pinkwae rain gauges. The Amrahia records have been kept since January 1968. There is a very high correlation between the rainfall recorded at Amrahia over the four-week

intervals and that recorded at Pinkwae (Fig. 15). The correlation is even higher, and the regression slope very close to 1.0 , when the three highest rainfall records are omitted; it is expected that local variation should be greatest during heavy storms due to gusting of wind, which may be quite variable over short distances.

Temperature information over the period January 1968 to March 1979 was obtained from the Ghana Meteorological Services Department. Records are from the meteorological station at Accra (Kotoka International Airport), which is the nearest temperature-recording station. The information includes the mean monthly maximum and mean monthly minimum temperatures, and the highest maximum and lowest minimum temperature in each month.

Information on daylength was calculated from tables of sunrise and sunset for a latitude of 5°N, taken from the Nautical Almanac, U.S. Government Printing Office.

Detailed microclimatic observations were made at Pinkwae on two occasions during the study, one during the major dry season (24 January 1978) and one at the end of the major wet season (9 August 1977). In each case, records were made at 15-minute intervals over a 12-hour period of temperature, relative humidity (using a sling psychrometer), and wind speed in four different microhabitats: open

Regression of rainfall at Amrahia Dairy Farm against rainfall at Pinkwae for four-week periods. Solid line (all points), $r = 0.800$, 31 d.f.; $P < 0.001$. Dashed line (circled points omitted), $r = 0.849$, 28 d.f.; $P < 0.001$. Rainfall in mm.

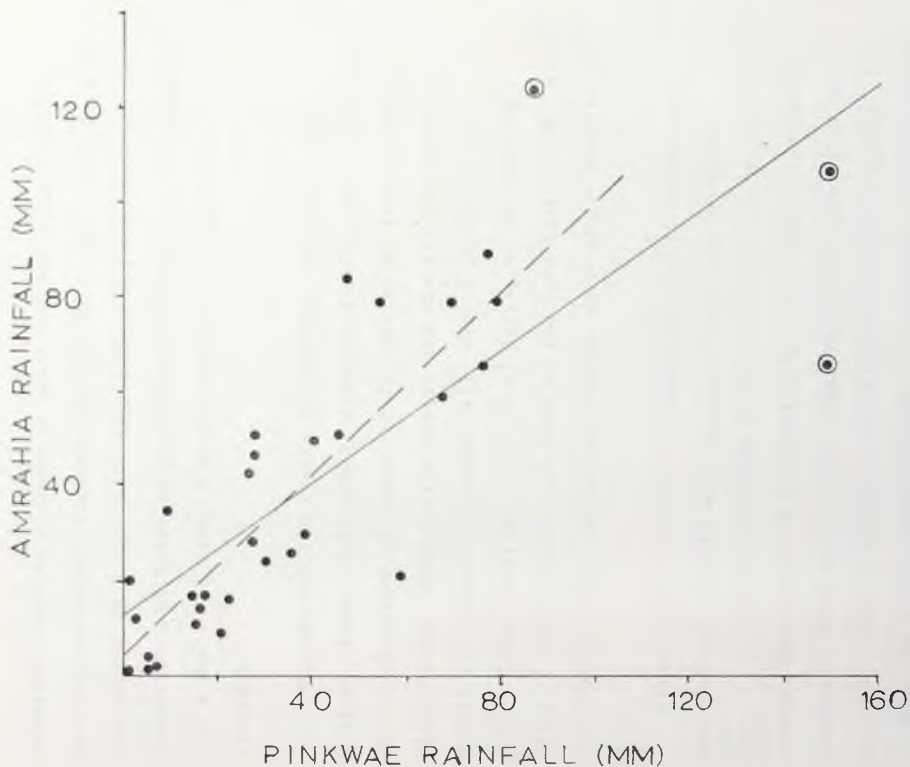

grassland outside Pinkwae; a small thicket clump; and at two heights within Pinkwae (1.5 m, and in the lower part of the canopy at 5 m). A 48-hour record was also made of the temperature at three heights within Pinkwae (ground level, 1.5 m and 5 m), using a Grant continuous temperature recorder.

The reproductive status (flowering, fruiting) and foliage status (full crown, dropping leaves, bare, flushing, or a combination of these) of 79 species of trees, shrubs, climbers and herbs in the forest and the thicket/grassland mosaic were assessed periodically over a period of 28 months (mean interval, 9.5 ± 0.83 days), on 95 sampling dates. (When visits were made on two consecutive days, the observations were pooled and treated as a single sampling date).

Plants were recorded as flowering only if opened buds were present; plants with unopened buds were recorded as such. Plants were recorded as fruiting only if fruits were present which were of a potentially dispersable size and/or ripeness; those with green, immature fruits were recorded as such. This is an important distinction for a number of species: Coffea ebracteolata, for example, produces flower buds which may remain dormant for weeks or months, opening

for a short period following rain or a drop in temperature (Corner 1940); and Millettia thonningii, which flowers at the end of the dry season, produces pods which remain green for most of the year, and disperses its seeds only during the following dry season.

An attempt was made to visit the same individuals in each species repeatedly, to avoid confusion when the reproductive behaviour of a population was not in synchrony; further, notes were made on the extent of synchrony within the population.

Foliage changes were somewhat more difficult to record reliably. Leaf tagging experiments undertaken in the Shai Hills (Swaine, Hall, Lieberman and Dakubu, unpublished) have shown that leaves which appear to be newly flushed (small and brightly coloured) may, in fact, be several months old. For this reason, only those leaves which had not yet hardened, being thin and limp in addition to the above traits, were considered to be new flushes. Such leaves are rarely maintained in an unhardened state for more than a few days after flushing, at least in the study area, as they are a significant liability to the plant in terms of water loss and potential herbivore damage. This criterion has decreased the chances of recording older leaves as flushes, but has increased the chances of missing flushes altogether; the

latter problem is probably minimal, as the interval between records was small (and was smaller than usual during periods of high phenological activity), and the branches of most plants tended to flush sequentially over a period of two weeks or more.

The other foliage states (full crown, dropping leaves, or bare) were less difficult to assess. Again, the same individuals in the population were visited repeatedly, and notes made on population synchrony.

Records were made of potential pollinators, seed dispersal agents, and herbivores which were sighted in the study area. The presence of mammals or their sign (droppings or footprints) was recorded, and notes were made on the abundance of butterflies, caterpillars, beetles and other insects. New flushes of leaves were sometimes found to be severely damaged by caterpillars, and this was recorded. Evidence of seed predation by rodents or insects was also recorded.

Seasonal fluctuations in radial growth were recorded over a period of 15 months. An inexpensive and easily-built spring-mounted band dendrometer was devised for rapid, precise measurement of girth changes on large samples of trees. The dendrometer is made of aluminium banding material

(0.5 inch wide x 0.012 inch thick, supplied by Stannite Automatics Ltd., Oakleigh Road North, London, N.20, U.K.) which is held around the tree bole at breast height, with about 10 cm of overlap, by a low-tension stainless steel spring (0.25 inch O.D., 0.023 inch stainless steel, 3.5 inch coil length, supplied by W.B. Jones Spring Co., Inc., Fairlane Drive, Cincinnati, Ohio 45227, U.S.A.). A small section of the outer lap of aluminium is cut away to expose the inner lap, and a vertical line inscribed over both laps. Any change in girth (increase or decrease) can then be measured, using a dial caliper, as the horizontal distance between the two marks (Fig. 16). The precision of these measurements is dependent only upon the precision of the caliper.

This dendrometer was modelled after that used by Karnig and Stout (1969), but differs from theirs in at least two ways. First, since their dendrometers are inscribed with a vernier scale, the manufacture of each dendrometer is more expensive and technically demanding; the version used here is so simple it can be constructed entirely in the field in about three minutes, and the cost per tree band is approximately 18 p (U.K.), depending upon the size of the tree. Second, the vernier scale of their dendrometer allows measurements to the nearest 0.01 inch (0.254 mm), while that used here allows measurements to the

Figure 16

Use of caliper and spring-mounted band dendrometer to measure girth change in banded Lannea nigritana tree. The points of the caliper can be lined up with the two inscribed lines on the aluminium band, and the distance between them (positive or negative) is recorded.

Figure 17

Use of caliper to measure diameter of trees too small to be banded. (Tree shown is Lannea nigritana). Caliper (with adjustment screw-loosened) is swung through a 360° arc, in order to record the largest diameter. Repeatability of measurements using this technique was quite high.



nearest 0.05 mm, using the dial caliper; this is just under five times the precision. Such precision is necessary for assessment of short-term changes, including diurnal girth fluctuations.

Dendrometers of this kind were mounted on 114 trees belonging to 12 species, and girth changes were recorded at intervals over a 15-month period (mean interval, 16.2 ± 1.32 days). The species and initial sample sizes are as follows: Antiaris africana (15), Lannea acida (4), and Millettia thonningii (3), all of which occur mainly in grassland, thicket, or forest margin; Dialium guineense (2), Diospyros abyssinica (24), Drypetes floribunda (21), Drypetes parvifolia (19), Lannea nigritana (18), Teclea verdoorniana (2), and Vepris heterophylla (2), all species of the forest canopy or lower part of the canopy; and Erythroxylum emarginatum (2) and Ocina membranacea (2), both forest understory species. The sample sizes at the end of the recording period were somewhat lower: 1 tree died of natural causes, 9 trees were felled by woodcutters, and 10 trees had bands removed which could not satisfactorily be replaced. (On several other occasions, some trees had only the springs removed, and the old bands were left at the base of the tree; these were re-mounted with new springs, if the mark on the bark from the old band was still visible.) All of the felled

trees were outside the forest. Fortunately, these losses were spread over several species, and no species lost all its banded members.

Among the five most numerous samples (Antiaris africana, Diospyros abyssinica, Drypetes floribunda, Drypetes parvifolia, and Lannea nigritana), trees were selected to cover a wide range of sizes, including saplings and mature or over-mature individuals. Saplings having a girth of less than about 10 cm could not be banded, and these were assessed by loosening the adjustment screw on the caliper (so that the gauge moved more freely), tightening the caliper around the sapling bole at a paint-marked height, and swinging the caliper around a full 360° so that the greatest bole diameter was indicated (Fig. 17). These diameter records were converted to girth change from the initial record for purposes of analysis.



Results

Seasonality

The correlation between daily rainfall figures from Amrahia Dairy Farm summed over four-week periods and four-weekly rainfall figures from Pinkwae is very high, and the slope of the regression line approaches unity (see Fig. 15). Because of the desirability of using daily rainfall figures, particularly in studies of phenology, the Amrahia rainfall data were used in the analyses done here.

The pattern of rainfall (Amrahia) during the study period (September 1976-March 1979) is shown in Figure 18, as is the pattern of daylength. The distribution of rainfall is bimodal for the year, with peaks occurring generally in March-April and October; dry periods occur in December-January and September, although the onset of the second (minor) dry period is variable. It is apparent from the figure that rainfall peaks coincide with daylengths of approximately 12 hours 05 minutes, which occur twice a year. Rainfall is not, however, restricted to these periods.

The reliability of rainfall in the study area was examined using rainfall records from Amrahia over the period 1968-1978. Mean rainfall for each month is plotted with standard error of the mean in Figure 19. Individual monthly rainfall figures in each of the past six years is



Figure 18

Plot of rainfall (mm) during the study period (1976-1979), and daylength during the same period. Rainfall data from Amrahia Dairy Farm. Phenology sampling ^{occasions} are indicated below rainfall.

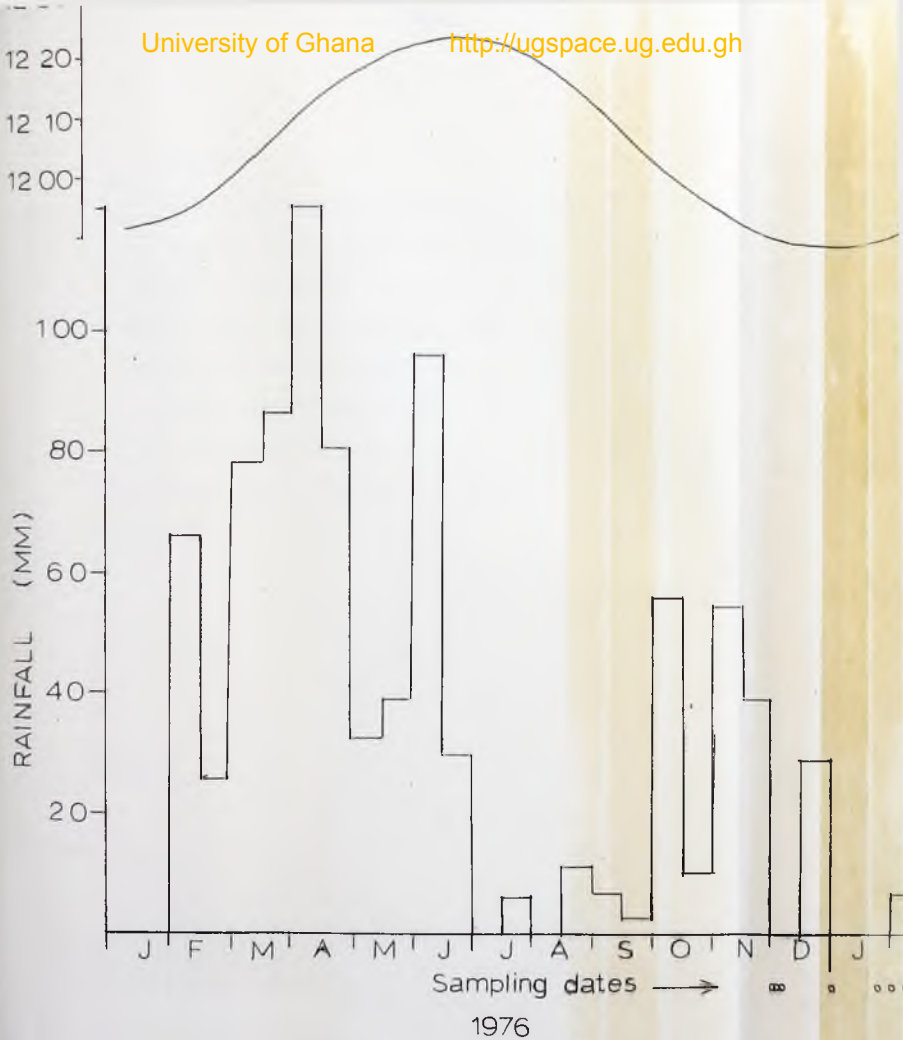
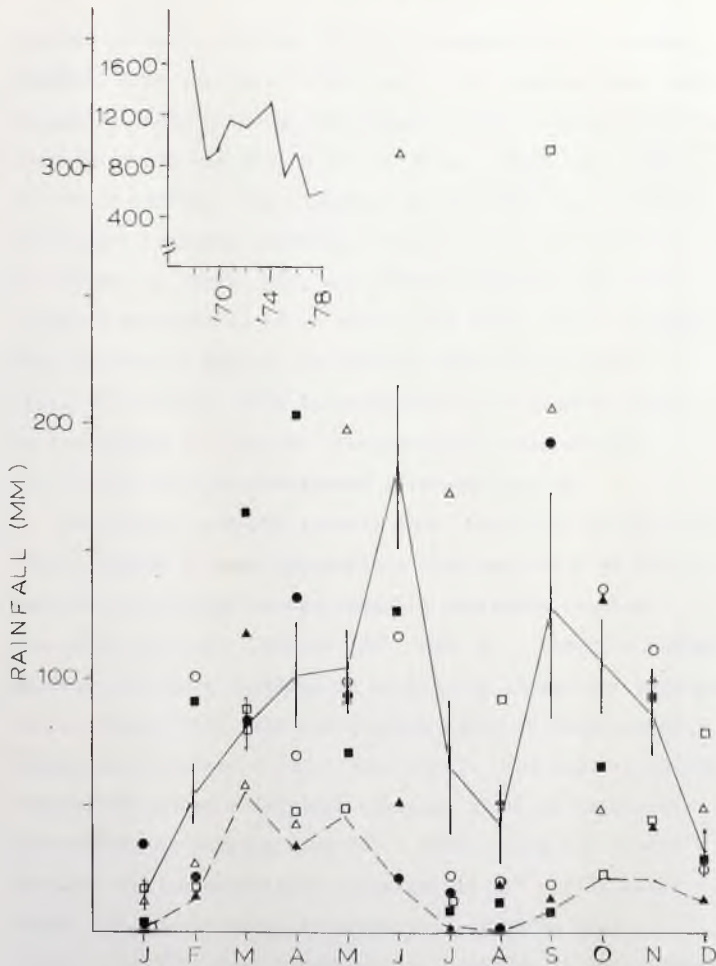

Figure 19

Monthly rainfall (mm) during the period 1973-1978; means and standard errors (vertical bars) based on records for the past 11 years. Dashed line at bottom represents the 11-year minimum rainfall for each month. Open squares, 1973; open triangles, 1974; open circles 1975; closed squares, 1976; closed triangles, 1977; closed circles, 1978. Inset in upper left-hand corner shows annual rainfall from 1968-1978. Data from Amrahia Dairy Farm.



plotted as well, showing the great variability in monthly rainfall from one year to the next. The highest mean rainfall occurs in June, although the range of June rainfall over the past six years was from a low of 20 mm (1978) to a high of 370 mm (1973). Dependability of rainfall, as judged by the lowest measured rainfall over 11 years, appeared to be highest in March, May, and October-November; the March rainfall exceeded 55 mm in every year since 1968. There has been an overall decline in rainfall from 1968 onward (Fig. 19, top). This is consistent with general trends in the region as a whole. The period of this study (1976-1979) must be considered a drought period.

Temperature records (Accra) show that there is relatively little change in mean temperature from one month to the next, and the temperature in any month is extremely constant from year to year. Figures 20 and 21 show the highest maximum and lowest minimum in each month (means and standard errors since 1968), and the monthly range of temperature (means and standard errors since 1968). The highest maximum temperature shows a distinct seasonal cycle of relatively low amplitude, ranging from 30° - 34°C , while the lowest minimum remains essentially constant at 21° - 22°C year-round. The daily range in temperature remains high (11.5° - 12.5°C) from December-May, dropping in July-August to around 9°C .

Figure 20

Monthly temperature extremes (highest daily maximum, lowest daily minimum) during the period 1973-1978; means and standard errors (vertical bars) based on records for the past 11 years. Symbols as in Figure 19 . Data from Accra.

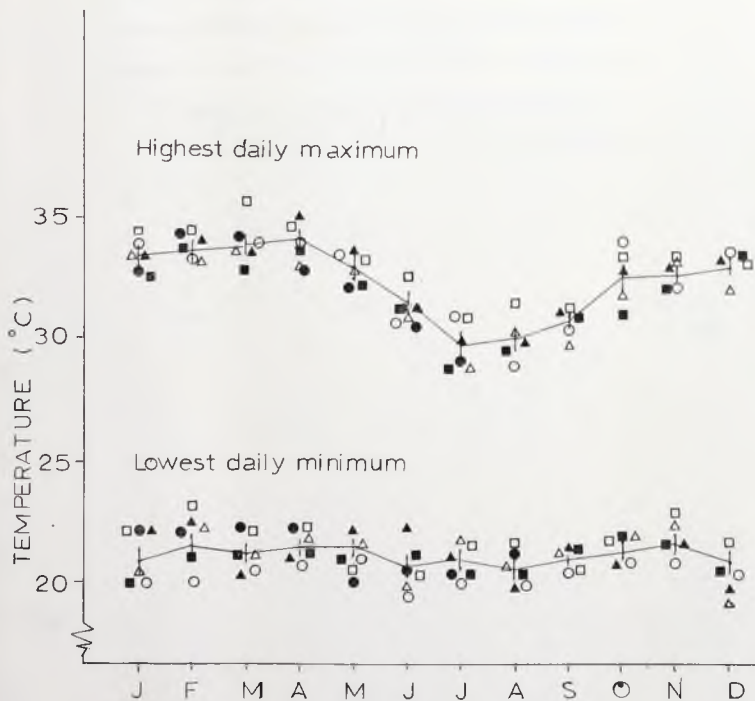
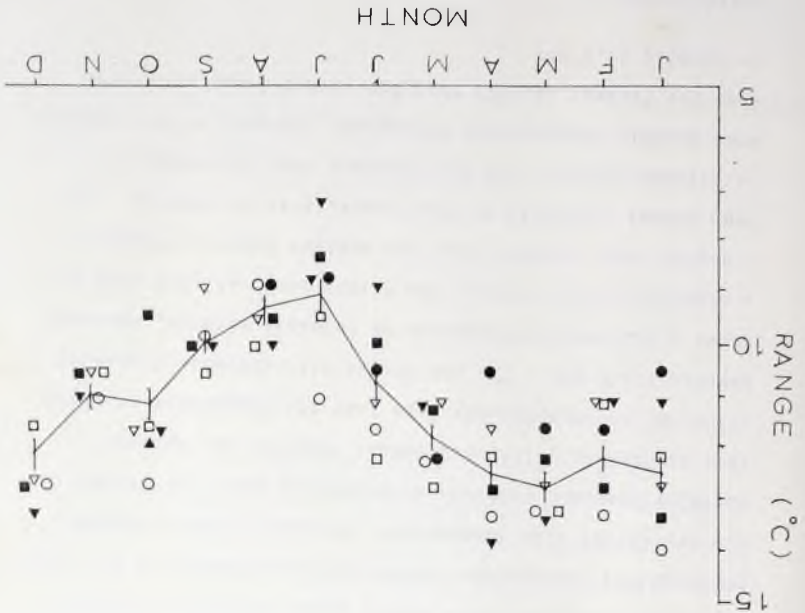

Figure 21

Monthly range of temperature (from lowest minimum to highest maximum) during the period 1973-1978; means and standard errors (vertical bars) based on records for the past 11 years. Symbols as in Figure 19 .
Data from Accra.



A hytherograph, showing the relationship between mean rainfall and mean temperature throughout the year, is plotted for the study area in Figure 22 . The extreme constancy of temperature, as compared with rainfall, is emphasized. For purposes of comparison, data are also shown for two Costa Rican forest sites for which extensive phenological records have been reported (Frankie et al. 1974). The dry forest site (Guanacaste Province) shows a bimodal, strongly seasonal rainfall distribution which is similar to that at Pinkwae. The mean annual rainfall at Pinkwae (1100 mm) is considerably less than the Guanacaste rainfall however (1500 mm). The wet forest site (Heredia Province) shows a seasonal distribution of rainfall without, however, a significant dry season; the driest month at this site has a higher mean rainfall than the wettest month at Pinkwae. Mean annual rainfall at the Heredia site is 4000 mm. It is evident as well from the diagrams that the range of mean monthly temperatures throughout the year is considerably less for Pinkwae (2.5°C) than for either Guanacaste (5°C) or Heredia (4.5°C).

Microclimate

Observations were made in the dry season and at the end of the wet season of the daily march of temperature,

Figure 22

Hytherographs showing mean monthly temperature ($^{\circ}\text{C}$) against mean monthly rainfall (mm) for three tropical forest sites: Pinkwae (solid line); a dry forest in Costa Rica (Guanacaste Province, Hacienda La Pacifica) (dotted line); and a wet forest in Costa Rica (Heredia Province, La Selva) (dashed line). Costa Rica data after Frankie et al. (1974). Values of mean annual rainfall are as follows: Pinkwae, 1100 mm; Guanacaste Province, 1500 mm; and Heredia Province, 4000 mm.

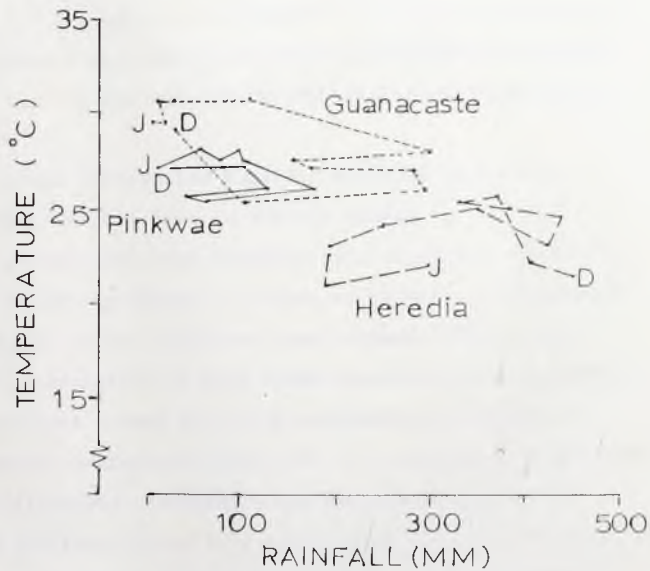

relative humidity and wind speed in various microhabitats in and around Pinkwae. Results are shown in Figures 23 and 24. The differences in temperature among five microhabitats (open grassland, a small thicket clump, ground level in the forest, 1.5 m height in the forest, and in the lower part of the canopy) were much less than temperature differences between the dry and wet seasons within these microhabitats (Fig. 25).

The range of relative humidity was less in the wet season observations than in the dry season; in the dry season, around noon, the humidity fell to 40-45%, while in the wet season it showed a minimum of 50-60%. Microhabitat differences, again, were less than seasonal differences.

The distribution of wind speed records in open grassland and the forest canopy show both microhabitat differences and seasonal differences (Fig. 26). Wind speed was highest in open grassland, reaching a maximum observed value of 7 miles per hour (3.2 m s^{-1}) with a mode of 5 in the wet season and 10 miles per hour (4.6 m s^{-1}) with a mode of 7 in the dry season. Wind speed was less in the forest canopy, with a maximum of 7 miles per hour (mode, 0) in the wet season and 7 miles per hour (mode, 4) in the dry season. No wind was recorded from the forest floor or understory. Wind speed was higher in the dry season than the wet

Temperature pattern in canopy and understorey during a 48-hr period in the wet season and during a similar period in the dry season.

----- canopy

———— 1 m

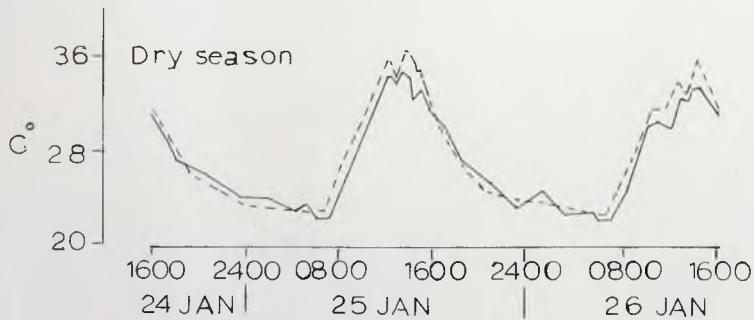
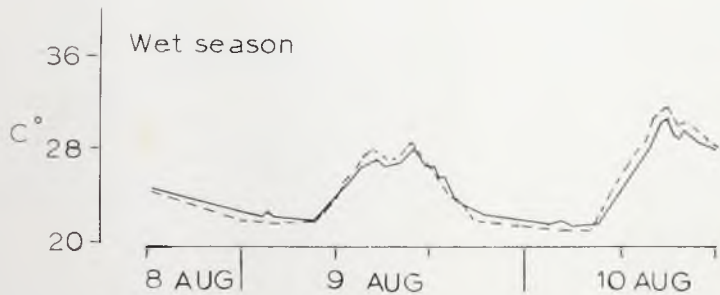

Daily march of relative humidity in three microhabitats on a wet season and a dry season day. Symbols indicated on figure.

..... grassland
 - - - canopy
 — 1.5m

Wet season

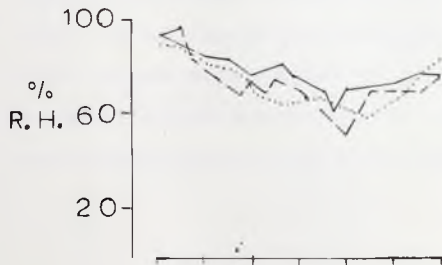

Dry season

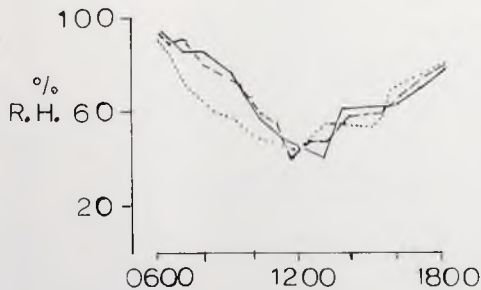

Figure 25

Temperature and relative humidity ranges in four microhabitats at Pinkwae on wet season and dry season days. (a) 48-hour temperature ranges at canopy height and 1.5 m above ground (forest). (b) 12-hour temperature ranges at canopy height, 1.5 m above ground, ground level (forest), thicket clump, and open grassland. (c) 12-hour relative humidity ranges at canopy height, 1.5 m above ground (forest), thicket clump, and open grassland. Solid lines, wet season; dashed lines, dry season.

(a)

(b)

(c)

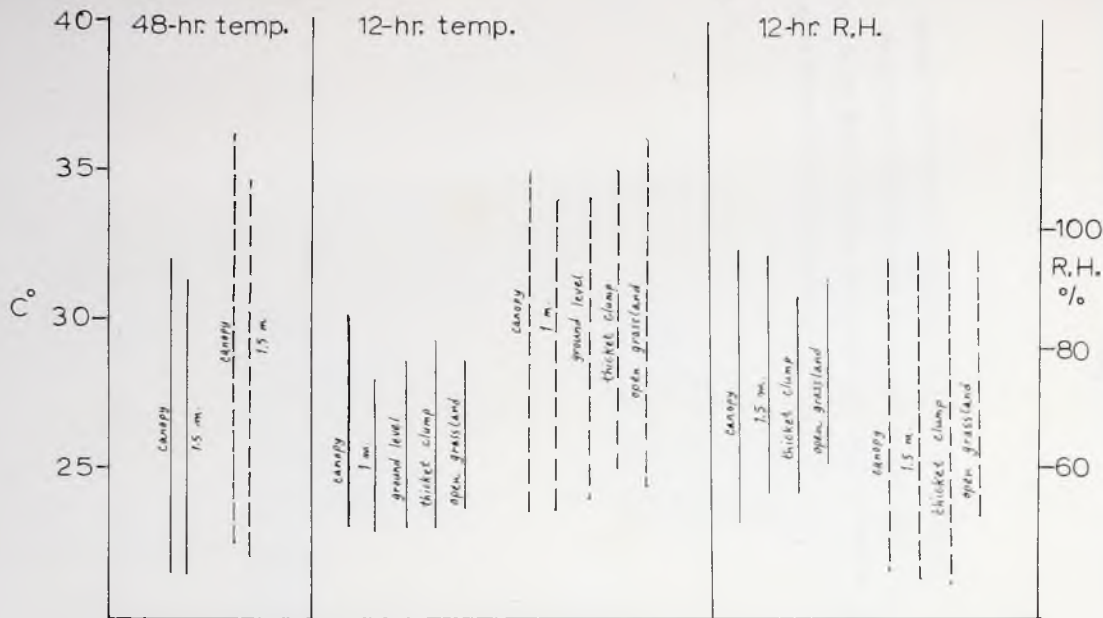

Figure 26

Frequency distribution of observed wind speed (miles per hour) in (a) wet season and (b) dry season. Open bars, forest canopy; solid bars, open grassland. Wind was absent from other microhabitats. Observation period was 12 hours.

season for both microhabitats. Wind blew sporadically during the day in the wet season, with the greatest wind speeds recorded around noon; in the dry season, the wind blew steadily in the morning between about 0800 hours and 0930 hours and in the afternoon between about 1400 hours and 1700 hours, being largely absent around noon. This pattern was found in both open grassland and in the forest canopy.

Results

Flowering and Fruiting

Records of flowering and fruiting were collected over a period of 28 months for 79 species in and around Pinkwae. The total number of species flowering and fruiting on each sampling date is shown in Fig. 27. Periods of high rainfall correspond to peaks in the number of species with flowers and fruits, but some flowering and fruiting was observed on every visit, even in the driest periods. The greatest number of species observed flowering on a single day was 28, or 35% of the species assessed; the greatest number of species fruiting on a single day was 20, or 25% of the total. The minimum numbers observed were one species flowering and three species fruiting.

A comparison of the number of species flowering on given dates in 1977 and 1978 shows close correspondence in phenology between the two years (Fig. 28a). Based on the number of species flowering in each two-week period, the correlation in number of species flowering between the two years is significant ($r = 0.627$, 22 d.f.; $P < 0.01$). The slope of the regression line (0.474) indicates that more species tended to flower on a given date in 1977 than on the same date in 1978. A similar comparison of the number of

Figure 27

Plot of number of species flowering and number of species fruiting on each sampling date. Dashed line, flowers; solid line, fruits.

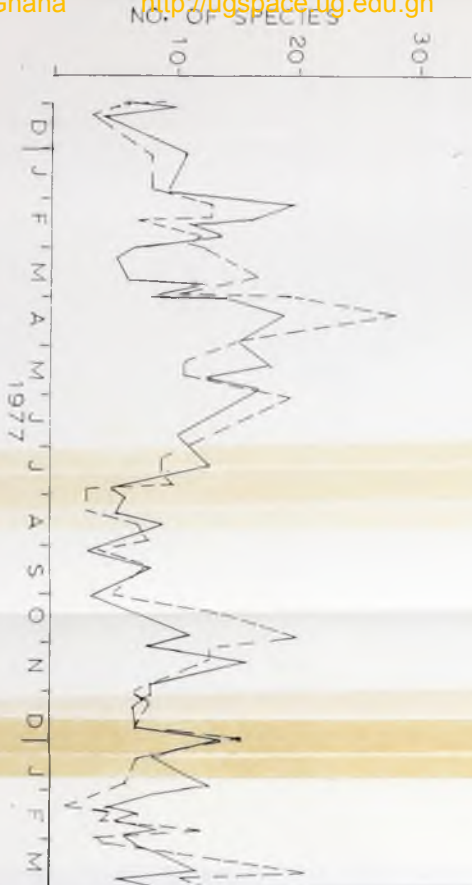
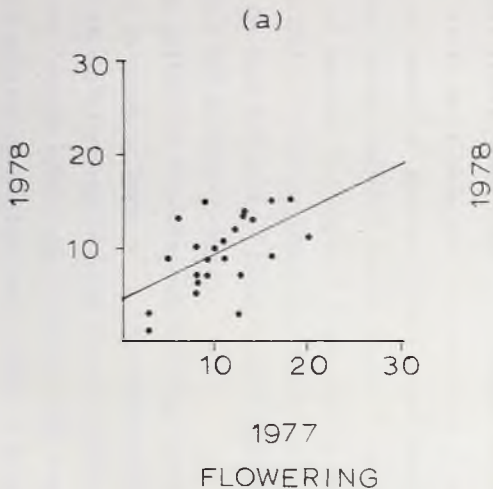

Figure 28

Comparison of reproductive phenology between two years.

(a) Regression of number of species flowering during two-week periods in 1978 against number flowering during the same periods in 1977; $r = 0.627$, 22 d.f.; $P < 0.01$. (b) Regression of number of species fruiting during two-week periods in 1978 against number fruiting during the same periods in 1977; $r = -0.008$, 22 d.f.; not significantly greater than zero.



(b)

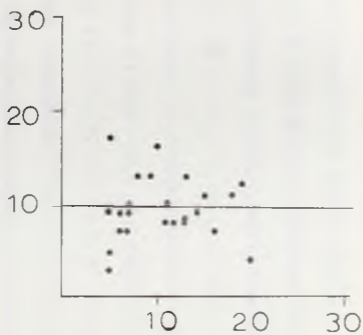

1977

FRUITING

PLS

species fruiting on given dates in the two years shows no significant correlation (Fig. 28b).

There is a significant correlation between rainfall over the preceding 21 days and the number of species in flower (Fig. 29) ($r = 0.451$, 93 d.f.; $P < 0.01$). No correlation could be demonstrated between rainfall over the preceding 21 days and the number of species fruiting (Fig. 30) ($r = 0.199$, 93 d.f.). Other intervals between rainfall and phenology which were examined (15 days, 30 days) for correlation likewise showed none. It is clear from both figures that there is a rainfall threshold, of around 35-40 mm of rain over the preceding 21 days, above which the number of species flowering and fruiting increases abruptly; higher rainfall levels appear to maintain the number of species in flower or fruit, but do not increase it substantially. This suggests that flower maturation and fruit set does not proceed below a particular moisture threshold (40 mm rain/21 days).

The pattern of flowering and fruiting in 46 individual species is shown in Table 2. The species are divided into five categories: savanna/thicket trees, savanna/thicket shrubs, geophytes, forest trees, and climbers. The flowering and fruiting pattern of savanna trees tends to be heaviest in the

Figure 29

Regression of number of species flowering against rainfall (mm) during the preceding 21 days; $r = 0.451$, 93 d.f.; $P < 0.001$.

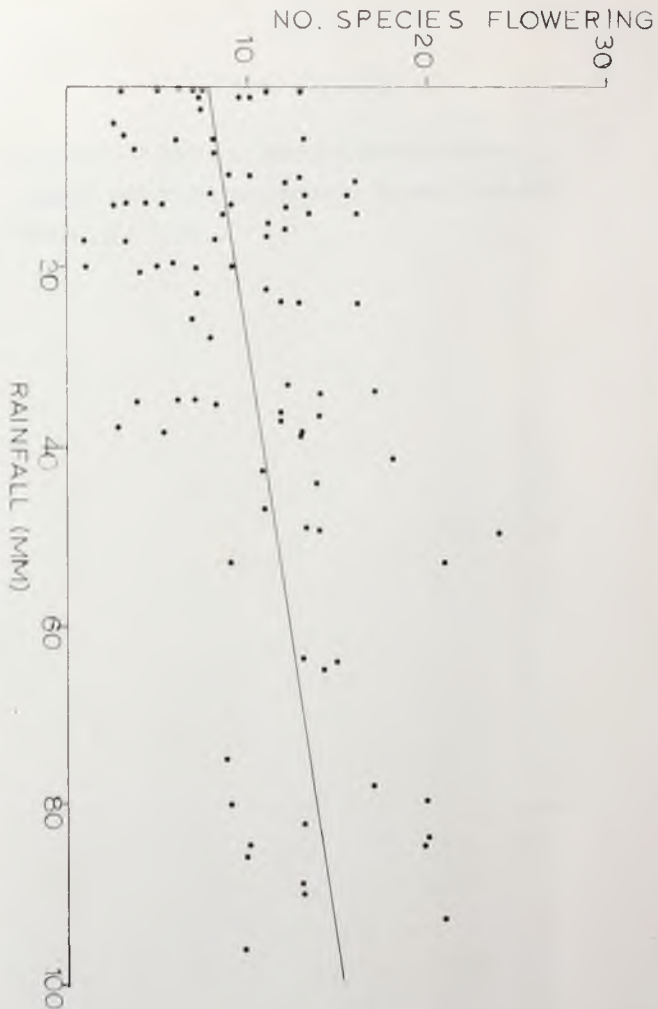
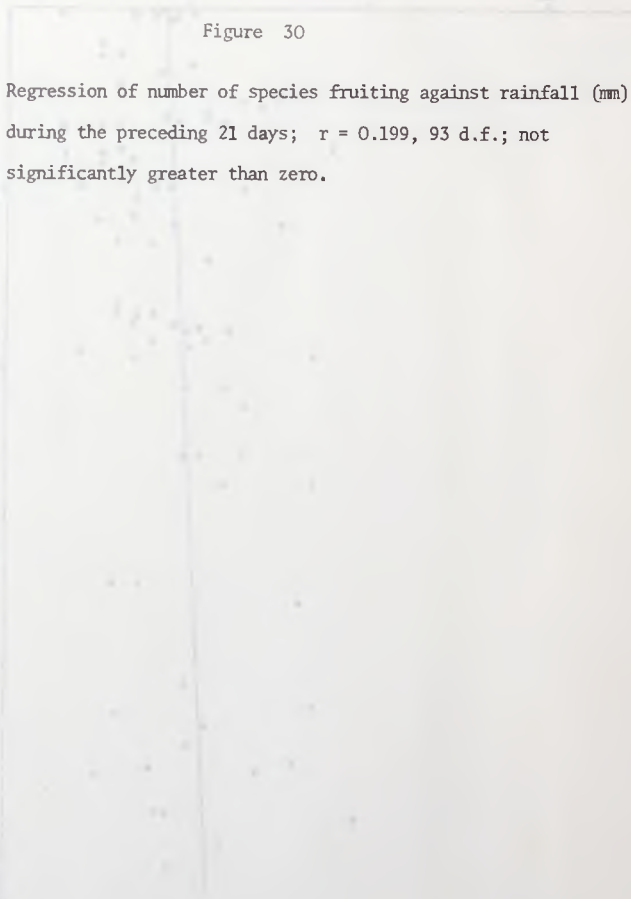

Figure 30

Regression of number of species fruiting against rainfall (mm) during the preceding 21 days; $r = 0.199$, 93 d.f.; not significantly greater than zero.



Flowering and fruiting patterns, 1976-1979; X - flowers; x - flower buds; O - fruits;
 o - immature fruits.

	1976			1977					1978					1979															
	D	J	F	M	A	M	J	J	A	S	O	N	D	J	F	M	A	M	J	J	A	S	O	N	D	J	F	M	A
GRASSLAND/THICKET TREES																													
<i>Gardenia ternifolia</i>	X			X	X		X	X	X		X				X												X	X	X
	o	o	o	o	o	o	o	o	o	o	o	o	o	o	o	o	o	o	o	o	o	o	o	o	o	o	o	o	o
<i>Zanthoxylum xanthoxyloides</i>	X						X	X	X	X	X		X		X		X	X	X	X	X	X							
													o	o	o	o													
<i>Lonchocarpus cyanescens</i>							X	X	X	X	X	X			X	X				X	X	X							
	o	o	o	o	o		o	o	o	o	o	o	o	o						o	o	o	o	o	o				
<i>Bridelia ferruginea</i>		X		X	X	X	X		X		X	X			X	X					X								
		o	o		o	o	o								o														
<i>Baphia nitida</i>	X	X	X	X	X		X		X		X	X	X	X	X					X	X	X	X	X	X				
	o	o													o	o											o	o	
<i>Millettia thonningii</i>		X	X																		x	x	X		X				
	o														o	o	o												o

58a

1976

1977

1978

1979

D J F M A M J J A S O N D J F M A M J J A S O N D J F M A

Ochna membranacea

X

X

X

X

0

Drypetes parvifolia

X

x x X

0

0 0 0

Vepris heterophylla

X X

0 0

Afraegle paniculata

X

X X

0 0

GRASSLAND/THICKET SHRUBS

Flacourtia flavescens

X

X

X

X

X

X

X

X

X

X

X

X

X

X

X

0

0

0

0

0

0

0

0

0

0

0

0

0

0

0

0

0

Ehretia cymosa

X

X

X

X

X

X

X

X

X

X

X

X

X

X

x

x

X

0

0

0

0

0

0

0

0

0

0

0

0

0

Clausena anisata

X

X

X

X

X

X

X

X

X

X

X

x

x

x

X

X

0

0

0

0

0

0

0

0

0

0

0

0

0

0

Hoslundia opposita

X

X

X

X

X

X

X

X

X

x

x

x

x

0

0

0

0

0

0

Allophylus spicatus

X

X

X

X

X

X

X

X

X

x

0

0

0

0

0

689

	1976			1977					1978					1979																			
	D	J	F	M	A	M	J	J	A	S	O	N	D	J	F	M	A	M	J	J	A	S	O	N	D	J	F	M	A				
<i>Ipomoea mauritiana</i>	X		X	X	X	X	X	X	X									X	X			X	X										
<i>Premna quadrifolia</i>										X	X			X	X	X										X							
<i>Paullinia pinnata</i>	X	X		X						X	X			X	X	X						X											
<i>Grewia carpinifolia</i>				X	X	X	X							X	X	X	X																
<i>Grewia megalocarpa</i>														X	X							X											
<i>Calycobolus heudelotii</i>				X														X															
<i>Acridocarpus smeathmannii</i>	X													X								X	X	X	X								
<i>Canthium multiflorum</i>				X	X					X				X	X			X				X	X	X	X								
<i>Strophanthus hispidus</i>				X	X																												

GEOPHYTES, PARASITE	1976					1977					1978					1979																					
	D	J	F	M	A	M	J	J	A	S	O	N	D	J	F	M	A	M	J	J	A	S	O	N	D	J	F	M	A								
<i>Scadoxus multiflorus</i>				X	X																																X
					0																																
<i>Eulophia cristata</i>				X	X	X							X	X													X										
						0																															
<i>Tapinanthus farmari</i>	X	X	X	X	X	X	X	X	X	X	X					X	X	X								X	X	X									
						0										0	0	0								0	0										

dry season. That of savanna shrubs tends to be more or less continuous (everflowering), some species producing flowers and fruits simultaneously over long periods, such as Carissa edulis and Securinega virosa, and other species producing flowers, followed by fruits, with a new crop of flowers appearing shortly thereafter, such as Ehretia cymosa and Clausena anisata. Very dry conditions appear to suppress flowering and fruiting in this group. Forest trees tend to fruit for fairly short, well-defined periods in the wet season(s). Climbers show an even mixture of all three patterns. Table 3 summarises these patterns.

Presence-absence data on flowering was ordinated using reciprocal averaging (Hill 1973). Stands were sampled on different dates, and the species record for each sampling date comprised the species which were flowering on that date. (Single occurrences of species were eliminated from the data prior to the ordinations of flowering and fruiting, as they tended to obscure the pattern). Figure 3 shows axes 1 and 3 of the ordination; in this and all subsequent ordination diagrams, axis values increase from left to right along the horizontal axis (0-100) and from bottom to top along the vertical axis (0-100). The ordination of stands (left-hand side of the diagram) brings about the separation of dates based on rainfall pattern; dry season dates have low axis 1 scores and wet season dates have high axis 1 scores. The

Flowering pattern of four categories of species from the Pinkwae area. There is a significant association between flowering pattern and species category ($G = 15.88$, 6 d.f.; $P < 0.025$).

	Dry season	Wet season	Continuous	Total
Grassland/thicket trees	6	2	1	9
Forest trees & shrubs	1	7	1	9
Grassland/thicket shrubs	1	4	7	12
Climbers	3	4	4	11
Total	11	17	13	41

Ordination of flowering data (Axes 1 and 3). Left-hand side, stand ordination (stands are sampling dates); Dates in the major wet season are indicated by closed circles; dry season dates are indicated by open circles; and dates in the minor dry season are indicated by half-filled circles. Right-hand side, species ordination: Species abbreviations indicated.

major and minor dry seasons are differentiated along axis 3. There is fairly close correspondence between the timing of rainfall seasons and actual calendar dates. The wet season, as defined in the ordination diagram, ranges from March-July and October-November in each year considered, with the minor dry season taking place from late July-October. All other dates fall within the major dry season.

The species ordination is shown on the right-hand side of the diagram. There is evidence of a cluster of dry-season flowering species having low axis 1 scores (Ximenia americana, Antiaris africana, Ceiba pentandra, Asparagus warneckei, Chaetacme aristata and Millettia thonningii). Except for Asparagus, these are all thicket trees. Species characteristically flowering in the minor dry season (high axis 3 scores) include Ficus capensis, Dracaena surculosa, Cassia siamea, Zanthoxylum xanthoxyloides, and Lonchocarpus cyanescens. Most other species flower in two or more seasons, or on the boundaries between seasons, and are therefore clustered together near the centre of the diagram. Other axes did not improve the resolution of this pattern.

Trends in flowering time and pattern were examined for species classified according to flower colour. Species with blue or purple flowers tend to flower in the dry season; these include Lonchocarpus cyanescens, Millettia thonningii, and Eulophia cristata, all savanna/thicket species. The

former two species are visited by a wide range of insects, including large and small beetles, small bees, ants, and various butterflies; the ground orchid Eulophia is visited by large bees. An exception to the above pattern is the slender climber Ipomoea mauritiana, which occurs in both forest and thicket and flowers in both the wet and dry seasons. This species has large trumpet-shaped flowers which are visited by butterflies, ants, and bees; it is likely that other pollinators, such as hawkmoths, may be important.

Species with red or pink flowers are found to flower at all times of year, some predominantly in the wet season (Ochna membranacea, for example, which has red sepals) and others in the dry season (Ruspolia hypocrateriformis); some species with red flowers produce flowers more or less continuously (Carissa edulis in particular). These include species of trees, shrubs and climbers in both forest and savanna/thicket. Insect visitors to these species were found to be mostly butterflies.

Yellow or yellow-green flowers are most often found on climbers; the exception to this is Cassia siamea, a large introduced savanna tree which produces large numbers of flowers more or less continuously. The yellow-flowered climber species flower both in the dry season (Acridocarpus smeathmannii)

and the wet season (Grewia carpinifolia).

The overwhelming majority of species considered in this study have white or cream-coloured flowers; this includes almost all the forest trees, almost all the savanna/thicket shrubs, and several climbers. Flowering in this group occurs in all seasons.

Fruiting data (presence-absence) were ordinated by reciprocal averaging; stands were sampling dates, and the species record comprised species which were fruiting on a given sampling date. Axes 2 and 3 of the ordination are shown in Fig. 32. (Axis 1 did not provide an adequate spread of points to be useful.) Ordination of stands (left-hand side of the diagram) brings about the separation on axis 2 of dates in the major wet season (high axis scores) from other dates. Dates which fell in the minor wet season are not isolated from dates in the dry periods, but are somewhat clustered within the dry season group. Interestingly, there is a clear division between the major wet season dates of 1977 and those of 1978 and 1979; there is a partial separation as well between dates in the latter two wet seasons, although this is less pronounced. The dry-season fruiting pattern showed no comparable between-year divisions. The species ordination (right-hand side of the diagram) reveals a general, although not complete, separation

Ordination of fruiting data (Axes 2 and 3). Left-hand side, stand ordination (stands are sampling dates). Dates which fell in the major wet season are indicated by closed circles; dry season dates are indicated by open circles; and dates in the minor wet season are indicated by half-filled circles. The division between wet season dates in 1977 and those in 1978 and 1979 is indicated by a dashed line. Right-hand side, species ordination: closed circles, fleshy-fruited species; open circles, dry-fruited species.

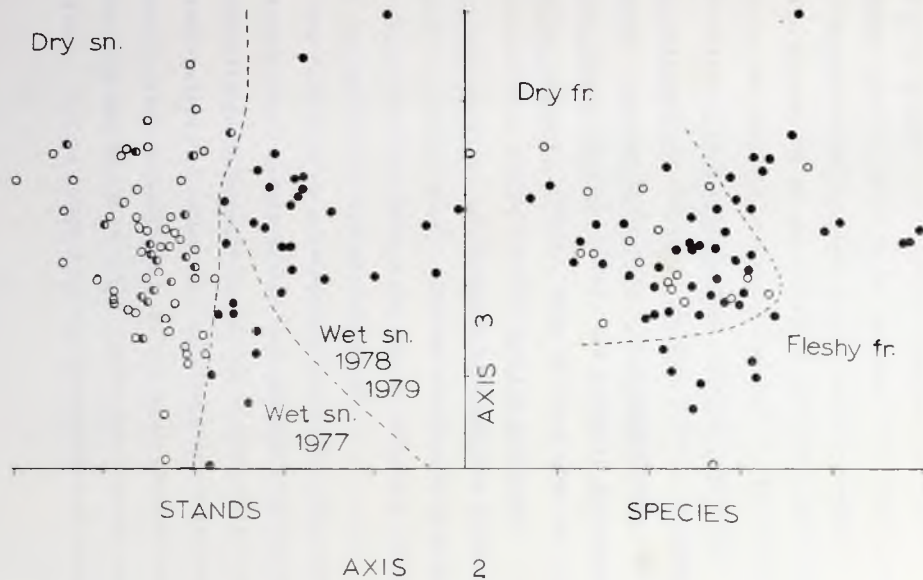

of dry-fruited species from fleshy-fruited species; the dry-fruited species (principally explosive or wind-dispersed) tend to fruit in dry periods (low axis 2 scores), while fleshy-fruited species fruit in all seasons.

The separation of wet season dates from year to year is due to the fruiting of several species in one year only: these include Afraegle paniculata, Dialium guineense, Vepris heterophylla and Vitex doniana (1977); Dichapetalum guineense, Drypetes parvifolia, Ochna membranacea and Mallotus oppositifolius (1978); and Antiaris africana and Oxyanthus racemosus (1979). Most of these species produced flowers at other times; only in Dialium guineense, Vepris heterophylla, and Antiaris africana was flowering limited to a single year. This would indicate that failure to produce fruit was frequently due to secondary factors, which did not affect flower initiation.

The fact that no between-year divisions were evident in dry season dates suggests that between-year replication of the fruiting pattern might be better in dry-fruited than in fleshy-fruited species. A comparison was therefore made between the number of years (between 0-3) in the study period in which dry-fruited and fleshy-fruited species were found to have set fruit. It was found that the mean number of years in which

dry-fruited species set fruit was 2.3 ± 0.22 , while that of fleshy-fruited species was significantly less: 1.7 ± 0.11 ($t = 2.695$, 79 d.f.; $P < 0.01$).

The more consistent fruiting from year to year of dry-fruited species could be brought about either by a more consistent pattern of flowering or alternatively by a greater success rate of flowering episodes. This was tested as follows: a comparison was made of the number of successful flowering episodes and unsuccessful flowering episodes (in which fruit was not set in the population) in dry-fruited and fleshy-fruited species (Table 4). A significant association ($\chi^2 = 6.066$, 1 d.f.; $P < 0.025$) was found between the success of fruit set and the fruit type; dry-fruited species set fruit in 83% of flowering episodes, while fleshy-fruited species set fruit in only 66%. (It should be emphasized that the success rate is measured here as a property of the species population, rather than the individual; rates for individual plants would be lower). Successful fruit set was taken in this analysis to include the production of young fruits, whether or not they attained dispersible size and maturity; it is thus evident that the assessed failure to set fruit in these species must take place at an early stage, either at or shortly after flowering.

Table 4

Comparison of success of fruit set in dry-fruited and fleshy-fruited species, based upon a total of 230 flowering episodes in 79 species. There is a significantly greater success rate in dry-fruited than fleshy-fruited species ($\chi^2 = 6.066$, 1 d.f.; $P < 0.025$).

	Dry-fruited species	Fleshy-fruited species	Total
Fruit set successful	49	113	162
Fruit set unsuccessful	10	58	68
Total	59	171	230

rather than by the abortion of half-ripened fruits. In fact, the abortion of immature fruits was seldom observed.

As far as is known, all the species for which phenological records were kept are pollinated by animals, predominantly insects. If the observed failure of the plant species to set fruit were due to pollination failures, then on statistical grounds alone there should be a greater proportional failure of fruit set in rare than common species (this would be expected whether the failure resulted from too few pollinator visits or too few transfers of conspecific pollen). For purposes of analysis, then, species were arbitrarily classified as either "rare" or "common" in the study area. (Without preconceived ideas on this point, an equal division was generated: 40 rare and 39 common species.) Success rates of fruit set were compared in the two groups (Table 5); it was found that the rate of successful fruit set was significantly greater in common than rare species ($\chi^2 = 18.278$, 1 d.f.; $P < 0.001$). Common species set fruit in 83% of flowering episodes, while rare species were successful in only 57%. This finding is entirely independent of the demonstrated association between fruit type (dry or fleshy) and the success of fruit set: there is no association between fruit type and commonness or rarity of species in the study area ($\chi^2 = 0.187$, 1 d.f.; not significant).

Table 5

Comparison of success of fruit set in species which are arbitrarily classified as "common" or "rare" in the study area; based upon a total of 230 flowering episodes in 79 species. There is a significantly greater success rate in common than rare species ($\chi^2 = 18.278$, 1 d.f.; $P < 0.001$).

	Common species	Rare species	Total
Fruit set successful	100	62	162
Fruit set unsuccessful	21	47	68
Total	121	109	230

Foliage Behaviour

Reliable records of foliage changes, including flushing and leaf fall, were obtained for 59 species, most of which were also included in the flowering and fruiting lists.

Foliage changes are much more coherent within the community than are reproductive changes. The number of species flushing on a given date corresponds closely to the level of rainfall (Fig. 33). When rainfall is low, flushing is generally absent altogether, while moderately high rainfall causes a highly synchronous response among the various species in the community. There were five main periods of flushing during the study period, and these correspond to the five wet seasons which occurred during the period. It appears that each major wet season (March-June) produces a major flushing period of several months' duration, which has two recognisable peaks; the minor wet season produces a minor flushing period of shorter duration but equal amplitude, in terms of number of species flushing/sample.

The relationship between rainfall during the preceding 21 days and number of species flushing was examined (Fig. 34). There is a highly significant correlation between the two ($r = 0.474$, 86 d.f.; $P < 0.001$). Because the large cluster

Figure 33

Plot of number of species flushing on each sampling date. Arrows below the diagram indicate dates on which butterflies were abundant. Number of species with insect-damaged flushes is plotted above. The dashed line shows the accumulated number of species damaged in each flushing period.

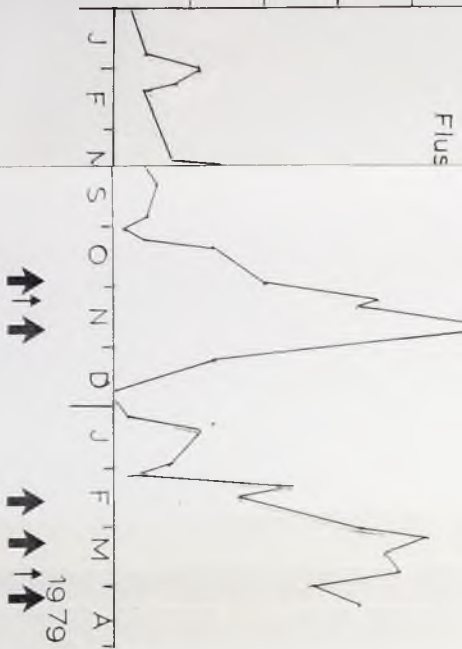

40

30

Dam

66b

SPECIES

V

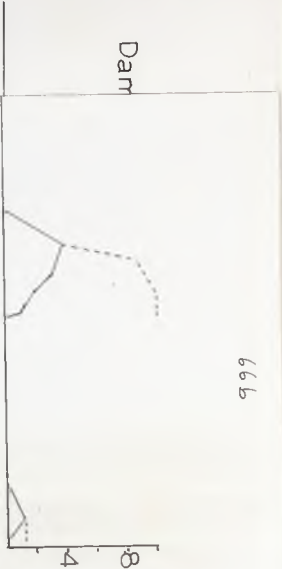

Regression of number of species flushing against rainfall (mm) during the preceding 21 days; $r = 0.474$, 86 d.f.; $P < 0.001$.

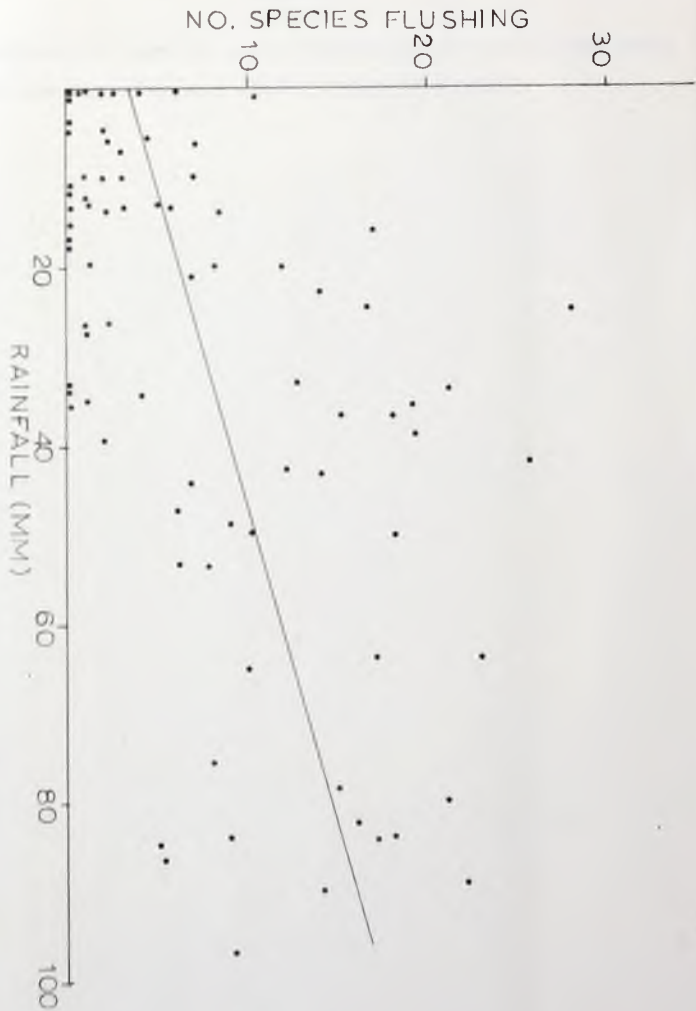

of points near the origin (low rainfall and low flushing) would have artificially raised the correlation coefficient, a plot was made with log-transformed data for rainfall; this was also significant ($P < 0.01$). A plot was also made using rainfall figures for the preceding 15 days, with the thought that leaf initiation might be more rapid than flower initiation; this showed a lower correlation, however, than the plot using 21-day rainfall figures.

It has been widely supposed that the synchronous flushing of populations and communities imparts a measure of protection against herbivory by restricting the availability of young, edible leaves to short periods, thereby maintaining pest populations at suppressed levels; the flushing period itself should be short enough (relative to the generation time of the pests) that the vastly increased carrying capacity produced is never attained by the pest population. If this is the case, certain predictions can be made: first, the period of flushing of individual species should be short; second, large numbers of species should flush in each flush period (whether or not the same species flush in each); and third, that selection should tend to maintain flushing within narrow limits, with flushing outside these limits being rare.

These three predictions were tested using flushing data from Pinkwae. First, the mean duration of flushes (days) was determined for each species population. (If flushing was observed on three consecutive sampling dates, it was assumed that flushing had continued throughout that period; the total flushing period for the species was taken to be the sum of days thus defined, plus half the number of days until the next sampling date. This criterion should lead to slight over-estimates of duration of flushes for populations, but all species should be affected equally). The frequency distribution of mean duration of flushes for each species is shown in Fig. 35a. Values range from 4-50 days, with a pronounced mode around 20 days. The number of flushes produced during the study period (28 months) varied from species to species (mean, 5.7 ± 0.28 flushes, with a range of 2-9); many species flushed two or three times during each major wet season. The total duration of flushing time was even more variable (Fig. 35b); total flushing days during the study period ranged from 11-302 days, with a mean of 110.5 days. The pronounced mode in mean number of flushing days per flush (Fig. 35a) suggests that this parameter has a rather narrow selective optimum.

A corollary of the above prediction is that flushes which are of longer duration than average should suffer proportionally

Figure 35

Frequency distributions of (a) mean number of flushing days per flush for each species; mean of these means is 18.5 days, with a range of 4-50; there is a pronounced mode around 20 days; (b) total number of flushing days (out of 28 months) for each species; mean duration is 110.5 days, with a range of 11-302.

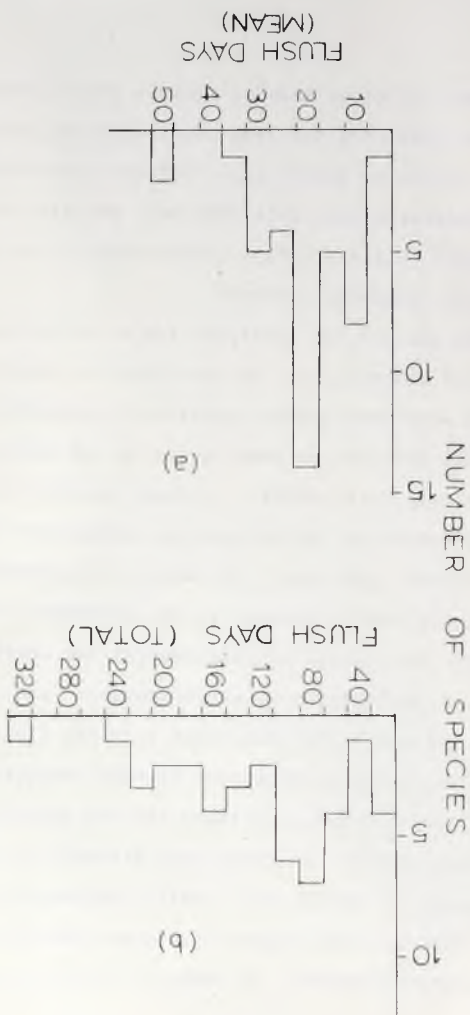

greater herbivore damage. In order to clarify the picture somewhat, species were divided into three groups: those without apparent defences; those with a hairy indumentum covering newly-flushed leaves; and those with presumptive chemical defences. The last group included species with leaves rich in aromatic oils (such as Rutaceae), strongly medicinal species, those with copious latex, and those with red flush colours (which may indicate the presence of anthocyanins). For each of the three groups, then, each flush of each species was classified according to its duration and to whether it had sustained significant herbivore damage (Fig. 36). (A species was considered to have had significant damage if the majority of individuals flushing showed evidence of herbivore damage. In many, but not all, cases, such damage led to the loss of some or all of the newly flushed leaves). Comparisons were made between duration of undamaged and damaged flushes using Student's t ; in each group of species it was found that damaged flushes had persisted for a longer period of time than had undamaged flushes.

The value of t was highly significant in the first two groups (unprotected and hairy species), and less so in the chemically protected group—this suggests that species protected by chemicals are less constrained in terms of flush duration than are other species, due to lower levels of

Comparison (Student's t) of flush duration (days) in undamaged and herbivore-damaged flushes for three groups of species. Above line, undamaged flushes; below line, flushes damaged by herbivores. Mean values indicated by arrows. In each group there is a significantly longer flush duration in damaged than in undamaged flushes. Species groups are (a) those with no apparent herbivore defences ($t = 4.759$, 78 d.f.; $P < 0.001$); (b) those with a hairy indumentum on newly-flushed leaves ($t = 14.585$, 45 d.f.; $P < 0.001$); and (c) those presumed to have chemical defenses ($t = 3.030$, 39 d.f.; $P < 0.01$). Flush duration (undamaged flushes only) is significantly longer in chemically-protected species than in unprotected species ($t = 2.163$, 103 d.f.; $P < 0.05$). Other comparisons showed no significant differences.

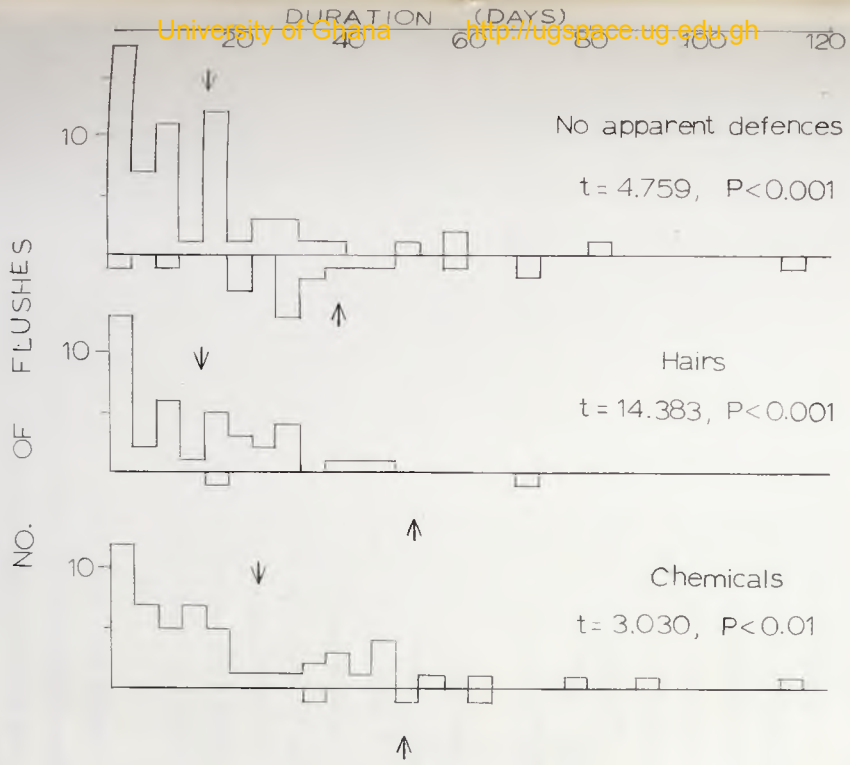

predation on even long-standing flushes. If herbivory is indeed less severe in chemically protected species, one would expect that the mean flush duration in such species might be longer than in other species. A comparison was therefore made of flush duration in the three groups of species (using only undamaged flushes); flush duration was found to be significantly longer in chemically protected species (mean, 24.5 days) than in unprotected species (mean, 15.61 days) ($t = 2.163$, 103 d.f.; $P < 0.05$). Other comparisons (unprotected vs. hairy, and hairy vs. chemically protected) showed no significant differences.

Despite the fact that unprotected flushes persisted for shorter periods of time than chemically protected flushes, the survivorship of chemically protected flushes was significantly greater than that of unprotected flushes (Table 6). Survivorship of flushes protected by hairs was also greater than that of unprotected flushes (Table 7). There was no significant difference between survivorship of chemically protected flushes and survivorship of those with hairs ($\chi^2 = 0.007$, 1 d.f.).

Inspection of Figure 33 reveals that the second prediction - that many species should flush simultaneously in each flush period - is satisfied; there are very few sampling dates which could be classified as "marginal",

Table 6

Comparison of survivorship in unprotected and chemically protected flushes. Flush survivorship is significantly greater in chemically protected leaves ($\chi^2 = 8.26$, 1 d.f.; $P < 0.005$).

	Undamaged flushes	Damaged flushes	Total
Chemical protection	54	3	57
No protection	62	19	81
Total	116	22	138

Table 7

Comparison of survivorship in unprotected flushes and those with a hairy indumentum. Flush survivorship is significantly greater in leaves protected by hairs ($\chi^2 = 6.59$, 1 d.f.; $P < 0.025$).

	Undamaged flushes	Damaged flushes	Total
Leaves hairy	39	2	41
No protection	62	19	81
Total	101	21	122

and the initiation and cessation of flushing within the community is strikingly abrupt.

The number of flushing days which occurred outside these well-defined flush periods was examined for each species. Figure 37 shows the frequency distribution of duration of flushes outside these periods. There are very few species which flushed at all outside the main periods; those which did were either species protected chemically, or were unprotected species which sustained damage to the particular flushes in question. Flushing data (presence-absence) were ordinated by reciprocal averaging, as was done with flowering and fruiting data. Stands were sampling dates, and the species record comprised those species which were flushing on a given date. Single occurrences of species were not eliminated from the data. Figure 38, right-hand side, shows that species which were characteristic of forest rather than thicket or grassland tend to be clustered at the low end of axis 1; species of thicket and grassland have higher axis 1 scores. Those which are found in both habitats (forest and grassland/thicket) are distributed throughout the diagram. Inspection of the stand ordination (Fig. 38, left-hand side) reveals that the low end of axis 1 is dominated by a cluster of sampling dates which

Figure 37

Frequency distribution of number of flushing days which occurred outside the five main flushing periods for each species; the majority of species flushed only during the main periods.

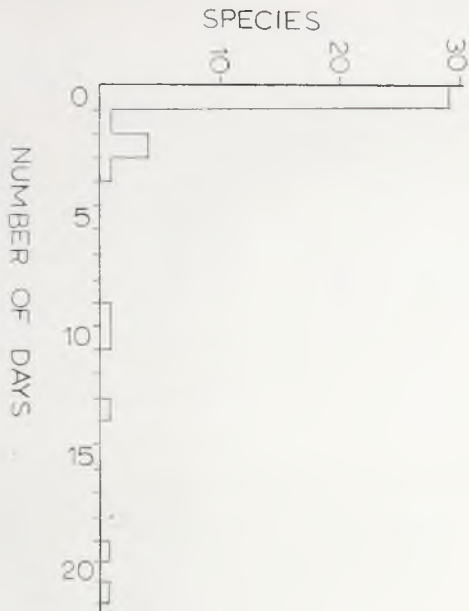

Ordination of flushing data (Axes 1 and 2). Left-hand side, stand ordination (stands are sampling dates). Dates which fell in the latter half of each major flushing period are indicated by closed circles; all other dates are open circles. Right-hand side, species ordination: closed circles, forest species; open circles, thicket and grassland species; half-filled circles, species common in both.

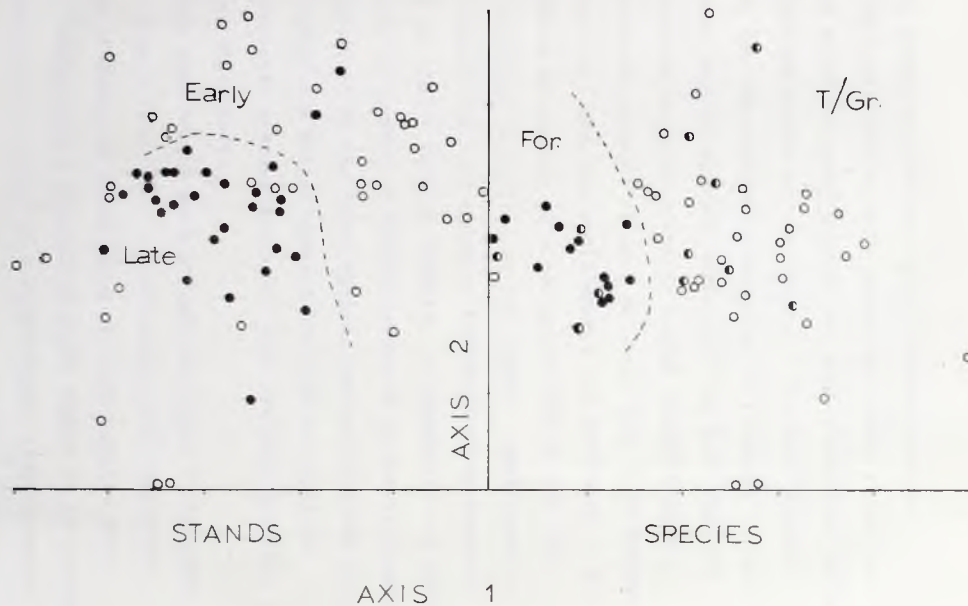

fell in the latter half of the major flushing periods. Dates in the first half of each period and those which fell outside the major flushing periods are more restricted to the upper right-hand corner of the diagram. The most probable explanation for the observed separation of flushing in forest and grassland/thicket species rests with the fact that the forest generally occupies slightly higher ground than the grassland/thicket mosaic; if soil moisture were a determinant of flushing time, then one would expect the threshold to be exceeded first in species on lower ground and slopes, and sometime afterward in species at the summit. Additionally, one might expect the soil moisture threshold to be reached more often on slopes than on summits. A comparison was therefore made between the number of flushes produced by forest species and that produced by the other species during the study period. The mean number for forest species was 5.50 and that for grassland/thicket species was 5.80; this was not, however, a significant difference.

Further axes of the same ordination proved to be useful as well. Axis 3 (Fig. 39, left-hand side) causes the separation of dates on which three or fewer species were flushing. While such a separation might appear to be generated by sampling error or noise in a conventional stand-species ordination, it need not be so in a study of flushing occurrence,

Ordination of flushing data (Axes 2 and 3). Left-hand side, stand ordination (stands are sampling dates). Open circles are dates on which flushes showed herbivore damage. Dates on which three or fewer species were flushing are excluded by the dashed line. Right-hand side, species ordination; species are grouped according to presumed defence mechanism: squares, chemicals; triangles, hairs; circles, no apparent defences. Open symbols indicate species which suffered damage to at least one flush during the study period.

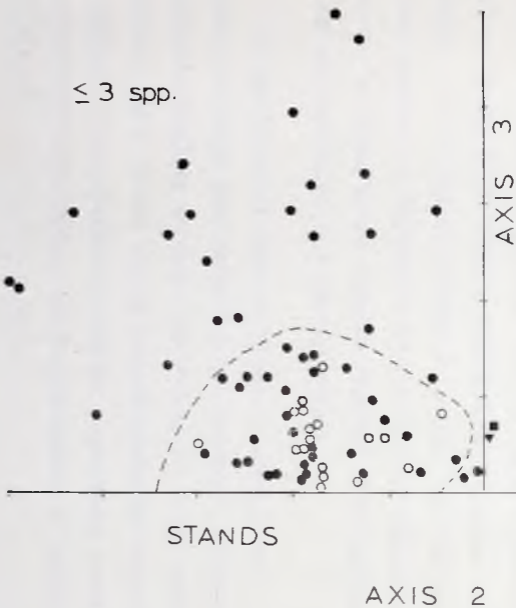

726

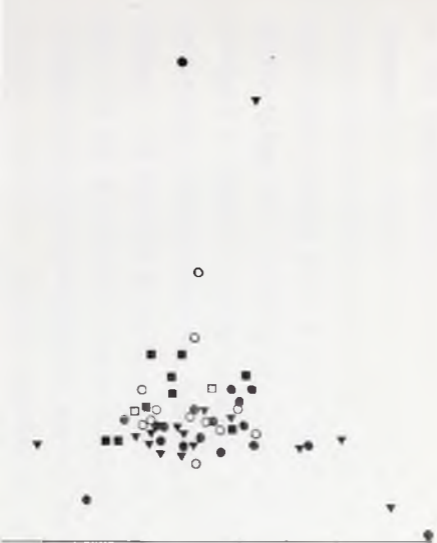

SPECIES

as the synchronization itself of species within the community is proposed to be of adaptive value. It appears, in fact, from the species ordination (Fig. 39, right-hand side) that species which tend to flush out of synchrony with others (high axis 3 scores) are those which have chemical defences or hairs on the new flushes, or alternatively are defenceless species which were found to suffer herbivore damage. The species which form the very tight cluster near the low end of axis 3 (synchronously flushing species) include most of the defenceless species and many of the species with hairs. Species presumed to be defended by chemicals (as defined earlier) form an upper border to the cluster, being less strictly confined to the major flushing periods. It is again worthwhile to point out the much better survival of flushes in protected than unprotected species, as shown in the diagram (species which suffered damage are indicated with open symbols).

Of the 27 forest species (trees, climbers, and shrubs) for which leaf behaviour was recorded, 19% were completely leafless at some time during the study period. In contrast, fully 55% of the 42 grassland/thicket species were deciduous. This represents a highly significant association between habitat preference and deciduousness of species ($\chi^2 = 8.953$, 1 d.f.; $P < 0.005$).

Leaf fall in deciduous species occurred during the four dry periods: mid-July to late October, 1977; late November to early March, 1978; early June to late October, 1978; and mid-November to early March 1979. The number of species which dropped leaves in the two major dry seasons (24 and 26 respectively) was not consistently higher than those dropping leaves in the two minor dry seasons (10 and 28); the percentage of these trees which became fully bare were 70% and 42% in the two major dry seasons and 60% and 40% in the two minor dry seasons.

Girth Changes

Seasonal changes in girth were recorded over a period of 15 months in samples of 12 tree species. Figure 40 shows the pattern of girth change in each species during that period. Girth change refers to the absolute gain or loss in girth since the time of banding; within each species, the mean and standard error of the mean girth change is given at each sampling date. (Where standard errors are not indicated, the record includes a single individual only.)

The seasonal pattern of girth changes observed showed varying degrees of synchrony within species. Trees of Lannea nigritana, Drypetes floribunda, and Drypetes parvifolia showed a relatively synchronous girth pattern within the species, while trees of Antiaris africana, Vepris heterophylla, and Erythroxylum emarginatum did not. Species which maintained a synchronous girth pattern within the population tended to show synchronous reproductive and leafing behaviour as well.

The pattern of mean girth changes throughout the year was generally similar between species, and was clearly related to the seasonal pattern of rainfall. Typically, there was a small girth peak at the start of the wet season (March 1978), which was followed by a decrease in girth occurring with the first flush of the year. At the time of flushing, some species were bare (Lannea nigritana, Lannea

Girth change pattern from February 1978 to April 1979 in 12 tree species. Means and standard errors indicated. Foliage and reproductive phenology indicated by the following symbols: open circle, bare, plus sign, flushing; filled circle, full crown; half-filled circle, dropping leaves; open star, flowering; filled star, fruiting. Species as follows: Tv, Tecllea verdoorniana; Vh, Vepris heterophylla; Mt, Millettia thonningii; Aa, Antiaris africana; La, Lanea acida; Dia g, Dialium guineense (note change in vertical scale for this and subsequent species); Ln, Lanea nigritana; Dp, Drypetes parvifolia; Df, Drypetes floribunda; Da, Diospyros abyssinica; Om, Ocina membranacea; Ee, Erythroxylum emarginatum.

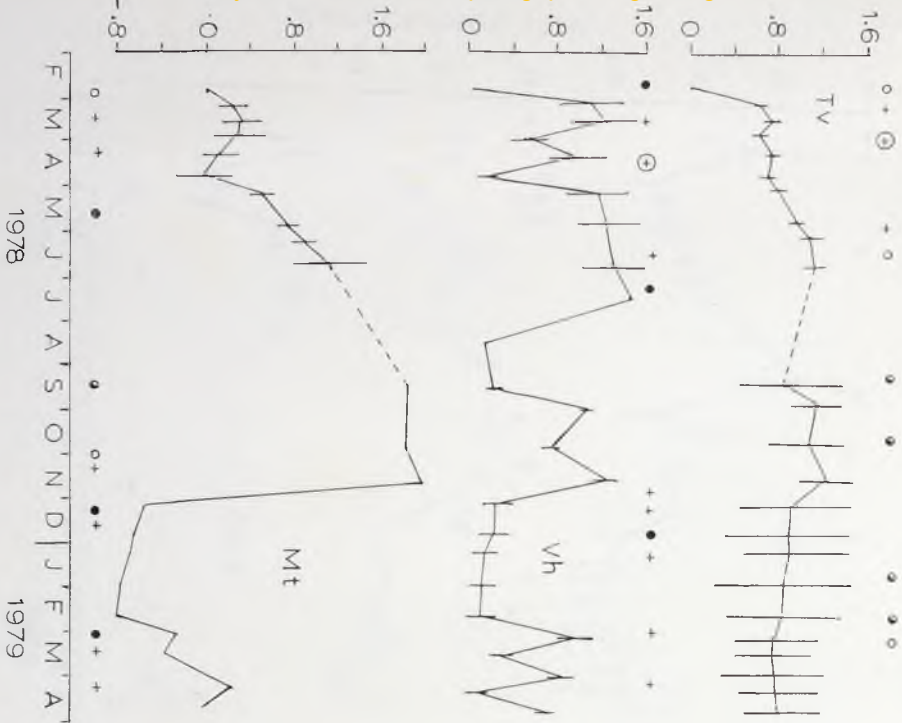

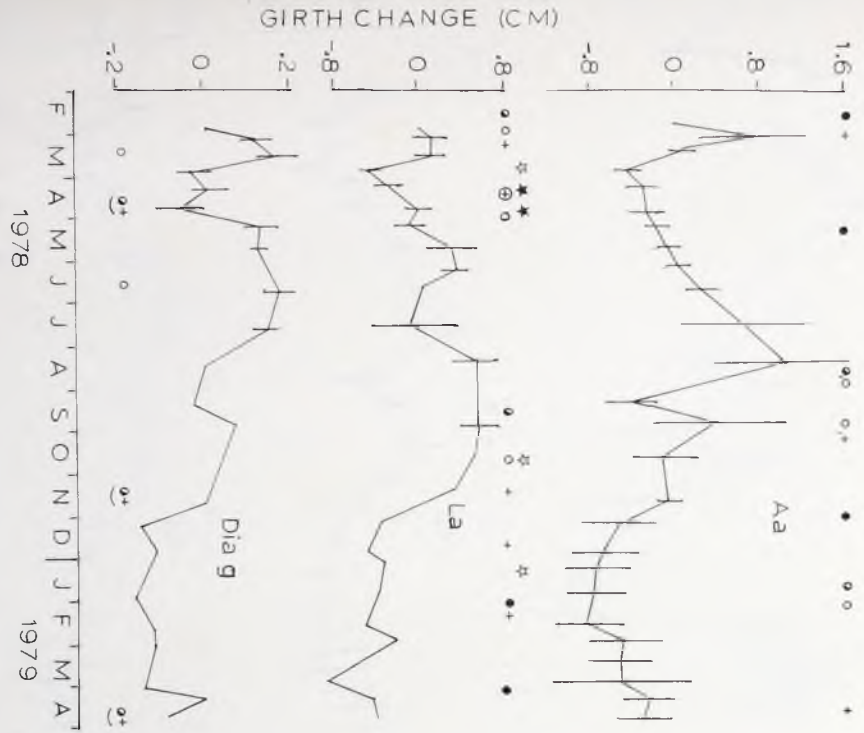

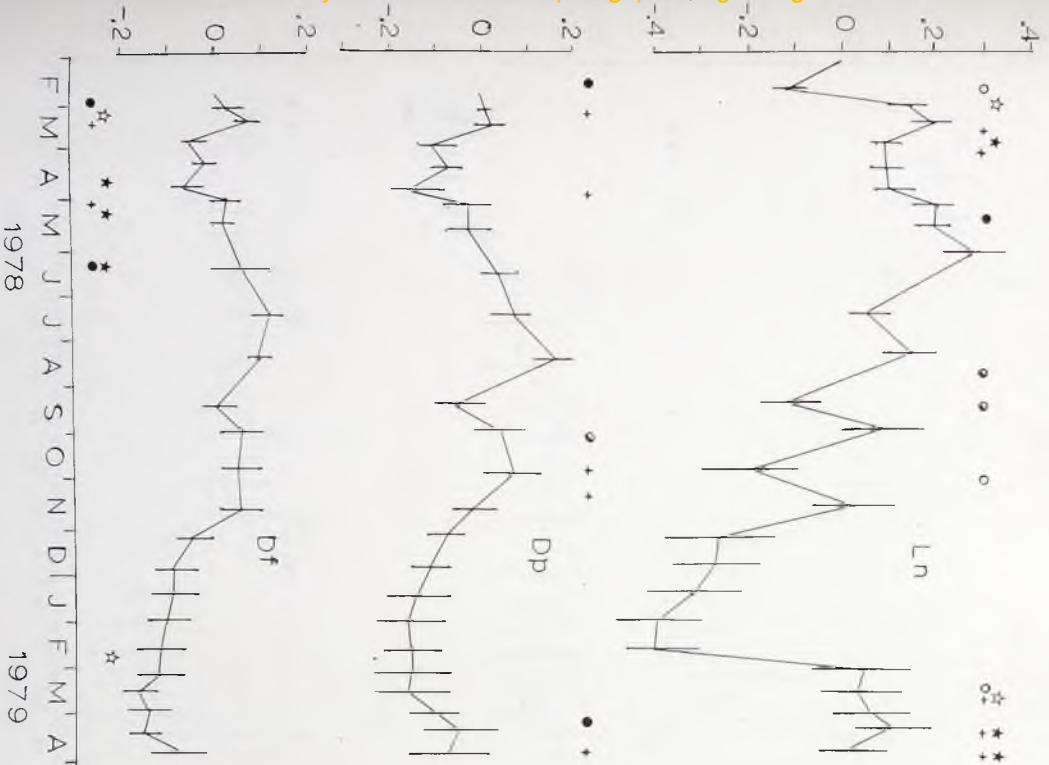

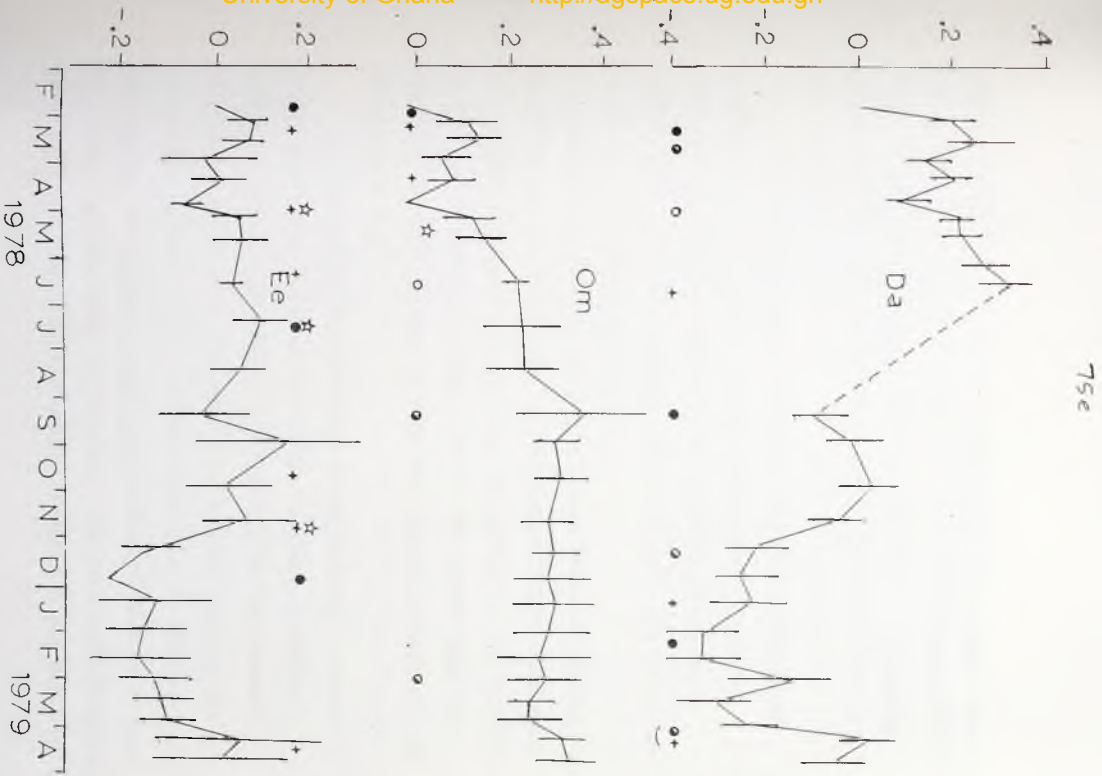

acida, Antiaris africana, and Millettia thonningii) while the remaining nine species had a full crown of leaves.

Trees of Dialium guineense and, in some cases, Diospyros abyssinica dropped their old leaves at the time that new leaves were appearing.

After the new leaves expanded, there was a gradual increase in girth, and a second (and sometimes third) peak was reached late in the wet season (between June-August 1978). At the time of this peak, all the trees had a full crown of expanded leaves.

Another girth peak occurred in most species at the time of the minor wet season (October-November 1978); following this peak there was a steady loss of girth through the dry season (until February-March 1979). The girth began to increase in most species in February, when the rainfall was still quite low.

Foliage status varied considerably between species during the latter part of the year. Deciduous species began dropping their leaves after the major wet season peak, and were bare by September or October (before the minor wet season). Some non-deciduous species (Ochna membranacea and Drypetes parvifolia) dropped leaves at that time also. At the time of the minor wet season, most species (both deciduous and non-deciduous) produced a new flush of leaves.

Both banded trees of Teclea verdoorniana lost their leaves and failed to produce new ones in 1979; they may be diseased or suffering from extreme moisture stress.

Flowering was observed in banded trees of five out of the twelve species; of these, trees in three species set fruit. Lannea nigritana flowered with regularity in early March of both years, while the tree was bare; fruit was set within a month of flowering in each case. Drypetes floribunda, a cauliflorous species, flowered around the same time in each year (February-March), although the extent of flowering in the population was far greater in the first year (1978). Fruit was set in 1978, around 6-7 weeks after flowering; the period of observations ended in April, 1979, at which time no fruit from that year's flowering had yet appeared. Lannea acida flowered during and just after flushing in late March, 1978, setting fruit about 3 weeks later; a second and third flowering episode in October 1978 and January 1979 each proved unsuccessful. Erythroxylum emarginatum and Ochna membranacea produced flowers but no fruit; flowering occurred three times in Erythroxylum emarginatum and was concurrent with flushing, while Ochna membranacea flowered ^{once} only, about a month after cessation of the first flush of the year. These comments pertain to banded trees only, comprising a very small subsample

of the various populations .

No relationship could be discerned between flowering and girth changes. The number of flowering events on which conclusions might be based was very small, however, and it would be necessary to obtain information on larger samples of trees over a longer period of time in order to test this rigorously.

Foliage behaviour was, on the other hand, clearly linked with girth changes. Flushing took place when the girth was at a peak, and was accompanied by a marked loss in girth caused, most probably, by a high rate of transpiration from the unhardened leaves.

The observed annual range of mean girth during the study period was greatest in grassland/thicket tree species, intermediate in forest canopy species, and least in forest understorey species (Table 8). This appears to be related to the degree of buffering against environmental fluctuations which is found in the three habitats: grassland/thicket trees are exposed to the greatest extent, and understorey trees to the least.

Fluctuations were much less regular and of greater (or equal) absolute amplitude, however, in saplings than in mature trees. This was found to be the case in all five species for which sapling girth changes were measured. Figure 41 shows the girth change pattern in seven

Girth range (based on mean girth change in each species), from February 1978-April 1979, in 12 species from three habitats.

Species	Maximum	Minimum	Range (cm)
Grassland/thicket			
<u>Antiaris africana</u>	+1.060	-0.806	1.866
<u>Lansea acida</u>	+0.583	-0.815	1.398
<u>Millettia thonningii</u>	+1.995	-0.790	2.785
	$\bar{x} = 2.016 \pm 0.407$ cm		
Forest canopy			
<u>Dialium guineense</u>	+0.188	-0.155	0.343
<u>Diospyros abyssinica</u>	+0.320	-0.334	0.654
<u>Drypetes floribunda</u>	+0.117	-0.168	0.285
<u>Lansea nigriflora</u>	+0.289	-0.413	0.702
<u>Teclea verdoorniana</u>	+1.215	0.000	1.215
<u>Vepris heterophylla</u>	+1.490	0.000	1.490
	$\bar{x} = 0.782 \pm 0.196$ cm		
Understorey			
<u>Drypetes parvifolia</u>	+0.157	-0.167	0.324
<u>Erythroxylum emarginatum</u>	+0.155	-0.230	0.385
<u>Ochna membranacea</u>	+0.358	-0.020	0.378
	$\bar{x} = 0.362 \pm 0.019$ cm		

Girth change pattern from February 1978 to April 1979 in saplings of two species, Diospyros abyssinica (4 saplings) and Drypetes floribunda (3 saplings). Initial girth (cm) of each sapling indicated. Absolute girth range of individual saplings during the year was equal to or greater than the girth range of individual adult trees in the species.

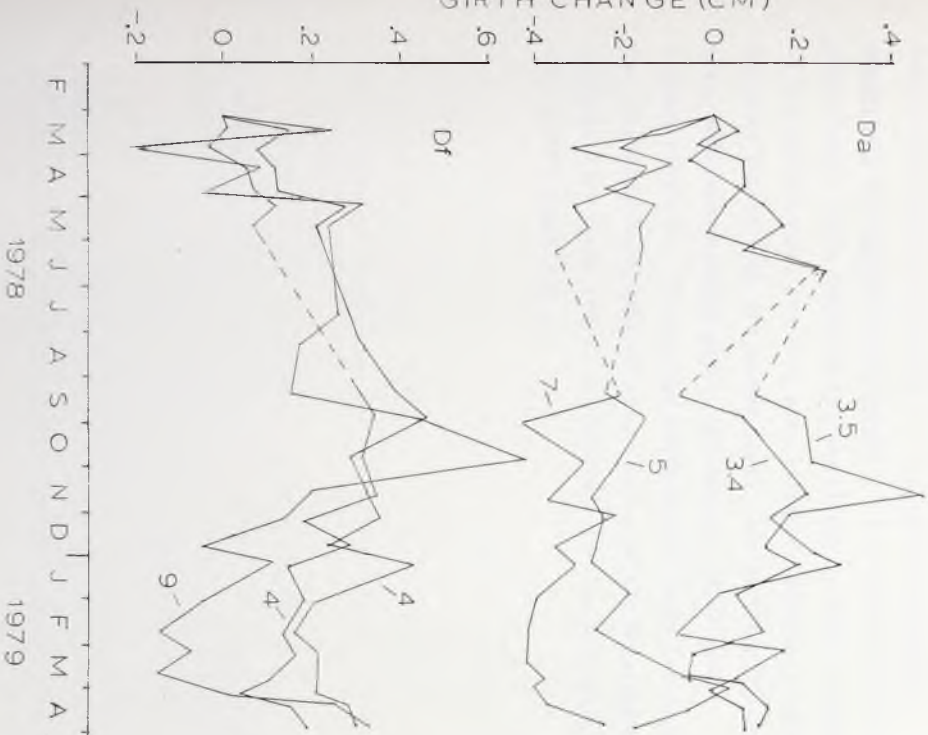

individual saplings belonging to two species (Diospyros abyssinica and Drypetes floribunda). It is likely that these individuals, while buffered to some extent by their position in the understorey, are less well buffered internally against moisture stress than are mature trees, due to their smaller size, shallower rooting depth, and poorer tissue-water storage capacity. The foliage behaviour in these saplings was comparable with that of mature trees in the population; saplings lost their leaves and flushed, for the most part, when mature trees did so.

REGENERATION AND GROWTH

Introduction

Regeneration in this chapter refers to the replacement of members of a species with others of the same kind in following generations. It is thus a property of populations, and is related to certain population parameters: population structure (size class distribution), size-specific survivorship, and size-specific fecundity (the use of size-specific, and not age-specific, criteria in this context has been recommended by several authors (Usher 1966, 1969, Hartshorn 1975, Harper 1977), and is discussed further under Methods). The interaction of these parameters determine the trajectory, through time, of a population.

It is perhaps significant that the chapter on Regeneration in Richards' classical work on tropical rain forest (1952) is among the shortest in the book; much of its content asks, rather than answers, questions. Studies of natural regeneration in undisturbed, unmanaged tropical forest are rare (Richards 1952, Longman and Jenik 1974), and regeneration in economically important species has,

understandably, received the most attention. Tree enumeration data collected throughout the tropics by various forestry departments have ensured that size class distributions of marketable timber species are relatively well known, at least within certain size ranges (Jones 1950, Richards 1952, Taylor 1960, Rollet 1974). Much of the information which has been collected is, however, either unpublished or otherwise inaccessible; Rollet (1974) has brought together data of this kind from a number of tropical countries.

Small trees and trees of little economic value have been virtually ignored by foresters, although their great abundance and their ecological and taxonomic diversity make them a particularly interesting group for study (Klinge ^{et al.} 1975). Enumerations have likewise been lacking in forest types which contain few (or no) species of economic interest. For this reason, dry tropical forests are among the least well known.

The size class distribution of a population is a reflection of its survivorship curve, and permits projections to be made concerning the extent to which the population is "replacing itself". The size class

distribution as well as the survivorship pattern may, of course, change with time in a population, for example in a population which has invaded a successional habitat; this has never been studied in a natural plant population (Hartshorn 1975).

In one investigation of the size class distribution of trees in a Nigerian forest, Jones (1955-1956) found that the numbers of shade-tolerant understorey trees decreased logarithmically with increasing size. No such relationship was found in light demanding emergents, which had few trees in the middle size classes and sometimes a complete lack of individuals in the smallest classes; there was thus insufficient stocking in the small classes among the emergents to replace the present large trees. This pattern is reported frequently, and is indicative of successional changes on the site (Knight 1975); due to the typically patchy nature of tropical forest (Longman and Jeník 1974), it may be that the size class distribution of these emergents would approach that of the understorey trees if a larger sampling area (including patches of different seral age) were considered.

The most detailed and most rigorously evaluated study of the population structure and dynamics of a tropical forest tree is that which was carried out by Hartshorn (1972, 1975) on the neotropical, wet forest tree Pentaclethra macroloba. Using matrix methods ingeniously adapted for the purpose, Hartshorn was able to model the trajectory of the size class distribution and population size through time (simulated generations). He found that the population was extremely stable; this is perhaps not unexpected for a widespread dominant tree. More interestingly, he found that, while mortality was highest among seedlings, drastic changes in seedling survivorship rates in this population had only slight effects on the future structure (and growth rate) of the population. Increases in mortality among the later stages, however, had a more critical effect.

In most natural forests, both temperate (Grubb 1977) and tropical (Richards 1952), regeneration occurs in clearings of some kind. Such clearings, which function as foci of regeneration, range from gaps up to a hectare or more caused by fire (Grubb 1977), cyclone damage (Whitmore 1974, 1978) or lightning (Whitmore 1978)

to tiny openings resulting from the fall of individual branches (Harper 1977). Indeed, the size, orientation, and location of a gap will greatly influence which species ultimately invade it (Grubb 1977, Hartshorn 1978, Whitmore 1978).

Recruitment of seedling populations depends upon the availability of "safe sites" in the environment (Harper 1977); these are sites in which conditions are met for the breaking of dormancy and for germination, and from which pathogens, predators, competitors, and toxins are absent. The lack of seedlings in an area may thus result either from the failure of seeds to reach the area, or from the absence of safe sites for seedling growth.

The first appreciation of inter-specific differences in regeneration requirements - that is, differences in the definition of safe sites - emerged from work in forestry; light tolerance was the first factor whose importance in this regard was recognized (Toumey and Korstian 1947). More recently, tolerance of root competition has been seen to be an important determinant of seedling establishment (Grubb 1977). Elegant experimental

work carried out principally by Harper and his associates has shown with certainty that the definition of safe sites differs between species in marked but often subtle ways (Harper and Sagar 1953, Harper et al. 1965, Harper and Benton 1966, Gutterman et al. 1967, Harper and Obeid 1967, Stolzy and Barley 1968).

The importance of differences in regeneration requirements in tropical species has been discussed by a number of authors (Jones 1955, Poore 1968, Richards 1969, Webb et al. 1972). The function of this "regeneration niche" in maintaining species diversity in plant communities was recently emphasized by Grubb (1977), who considers that the relevant dimensions of this niche must include, in addition to requirements for seedling germination and establishment, the phenology of flowering, pollination, fruit set, and seed dispersal. A cursory glance through the notes on natural regeneration in Ghanaian forest trees presented by Taylor (1960) is sufficient to convince one that there are nearly as many patterns of seedling abundance, distribution, dispersion, light requirements, and growth rates as there are species; it is also clear that little progress has been made in organizing this variation within an ecological framework.

Vegetative propagation is seldom mentioned in the literature on tropical forest regeneration, and appears to be comparatively unimportant. Certain "exceptional" species which are capable of vegetative reproduction are listed by Longman and Jeník (1974), but seeding seems to be vastly more common. In particularly harsh tropical environments, however, this may not be the case. In seasonally waterlogged forest, for example, species which reproduce vegetatively may dominate the herb layer (Richards 1952) and the lower and middle tree layers (Longman and Jeník 1974). Similarly, in dry tropical forest one finds extensive root suckering and coppicing, although by no means to the exclusion of reproduction by seeds.

Growth rates have been measured in seedlings and large individuals of a few forest trees. Growth tends to be both sporadic and remarkably slow in the suppressed, small size classes. Under favourable conditions of moisture and illumination, these rates may increase tremendously (Richards 1952). Average diameter increments in the Philippine forest tree Parashorea malaanonan were around 1 cm per decade during the first 100 years, and

this increased sharply to around 7 cm per decade during the second 100 years; in contrast, the same species grown in the open showed the higher growth rate (7 cm per decade) from the beginning. It may be inferred that the forest-grown trees spent a full century in the understory, achieving their maximum growth rate when they finally reached a height at which they were, effectively, in the open (Brown 1919).

Much faster rates of growth are found in secondary forest species, one extreme example being plantation-grown balsa (Ochroma lagopus) in Central America, which showed an annual diameter increment of 0.9 cm in its second year after germination; plantation conditions, however, undoubtedly produce faster rates than would occur in natural forest (Longman and Jeník 1974).

Over a two-year observation period in Nigerian forest, Hopkins (1970) found extremely low tree growth rates, many of the trees showing a negative average increment over the two years; Hopkins considers that these unusually low values resulted from the very low rainfall during the two years.

Other investigators have found growth rates to vary considerably between sites and between species.

Dawkins (1956) recorded a mean annual girth increment of 10 mm in a Ugandan forest, with a range of -1 mm to 15 mm; Lebrun (1936), working in the Congo, recorded a mean girth increment of 48 mm, and a range of 16 mm to 63 mm. Moisture appears to exert the greatest limiting effect on the growth rate of forest trees (Hopkins 1970).

Methods

A series of 11 permanent 5 m x 1 m plots were marked out for long-term seedling studies. Eight of these were located at random distances along a NW-SE transect across Pinkwae, and three were in thicket clumps near the northern margin of the forest (Fig. 5b).

All seedlings in each plot were identified and tagged; all plants less than 1 m in height were included, with the exception of root suckers. Measurements were made to the nearest 1 cm of the unsupported height of each seedling (ground level to the highest active meristem). The seedling plots were visited at two-month intervals for the next 24 months (13 sampling periods). Each tagged seedling was measured and a record was made of seedlings which had died; all new seedlings were identified, tagged, and measured. During the 24-month period, a total of 1,931 seedlings belonging to 53 species were tagged.

It was noted that seedlings of one relatively abundant canopy tree species, Lannea nigritana, were exceedingly rare; therefore, a few young root suckers of this species were tagged and measured with the rest of the seedlings.

In addition to the permanent seedling plots, a series of seedling samples were harvested at monthly intervals during the first year of sampling. A number of 1 m² quadrats

were laid out at various sites in Pinkwae and the nearby thicket clumps, with two replicates at each site; the sites were re-visited each month, but quadrats were placed so as to avoid old sample patches. All seedlings were uprooted from each quadrat and these were identified and counted. Seedlings of each species in each quadrat were pooled, oven-dried, and weighed. The purpose of the harvesting scheme was two-fold: first, it was desirable to determine whether a monthly seedling assessment interval would be preferable to the two-month interval being used in the permanent plots; it was concluded that the two-month interval was indeed adequate to monitor fluctuations in the seedling population. Second, it was not known whether soil impaction, or the repeated manipulation of plants in the permanent plots, however carefully done, might affect survivorship or recruitment of seedlings; it was found that trends in seedling density were similar in the permanent plots and the harvested samples, and it was concluded that the experimental manipulation was probably an insignificant factor.

In order to ascertain and compare the seed content of soils from grassland, thicket clumps, and the forest, two experiments were carried out. In the first, samples of soil were collected from recently burnt and unburnt grassland

and from a thicket clump. The three samples were collected from within 5 m of one another. The soil samples ($1 \text{ m}^2 \times 0.05 \text{ m}$) were brought to Legon, where each was thoroughly mixed and then divided into two parts, one part being planted in full sunlight and the other under an artificial canopy. The samples were watered regularly, and all seedlings which germinated were recorded.

In the second experiment, samples of soil were collected from three sites in the forest. These samples ($0.5 \text{ m}^2 \times 0.05 \text{ m}$) were brought to Legon and left in full sunlight, and were watered regularly. Near each of the three sampling sites in Pinkwae a comparable area was demarcated for assessment of seedling germination during the same period; these were cleared of any seedlings already present, and new seedlings were recorded on subsequent visits.

The growth rates of seedlings measured (to the nearest 1 cm) during the two-year period were too slow, in terms of observational resolution, for direct plotting of growth curves. For this reason, the indirect method of estimating growth curves based on passage time of individuals in each size class was used. The passage time refers to the length of time in which an average seedling moves from a given size class to the next size class, and is calculated as follows:

if the proportion of seedlings of size i which move from class i to class $i+1$ over a one-year period is p , it can be predicted that all members of class i will have moved to the next size class in $1/p$ years (for example, if 0.25 move to the next class in one year, all will have moved in 4 years).

It should be noted that forest tree seedlings do not generally grow continuously, but may respond to increased light or moisture in some seasons by increased growth rates, being essentially dormant at other times; and some may not grow at all for a number of years, later growing very rapidly when a gap in the canopy appears. In a North American fir forest, for example, seedlings of the three dominant species spent as much as 40 years before reaching sapling or transgressive size (Oosting and Billings 1951). Such patterns may not be apparent from studies of growth rings alone, as cores or sections taken at breast height would miss much of this period in the history of a tree (Harper 1977); long-term studies of tagged individuals may, on the other hand, provide information of this sort.

The differential mortality of seedlings subjected to moisture stress may depend upon the relative ability of different species to obtain and conserve water from the soil. Measurements were therefore made of the length of the root and above-ground shoot for seven species (five trees

and two climbers), using seedlings collected from the field at the first-leaf stage.

Information on the size class distribution of 13 species of trees was compiled. Data were collected as follows: a series of 37 plots, 10 m x 10 m in size (0.01 ha), were laid out in all parts of the forest, including marginal areas. All trees 3 m in height or greater were identified and girthed; all species of climbers in the canopy were listed, and all climbers 5 cm in girth or greater were identified and girthed; all saplings (between 1-3 m in height) within a 50 m² subsample were identified and counted, and their height recorded to the nearest 1 m; and all seedlings less than 1 m in height within a subsample of four 1 m² quadrats were identified and counted. The results of these enumerations were pooled to determine the size class distribution of each species. Girth values of trees were converted to basal area (cross-sectional area of the bole at breast height); seedlings and saplings were each considered to be a single size class. Basal area was considered to be more useful than either girth or diameter, as it is linearly related to the tree biomass. At the same time that the girth sampling was done, notes were made on canopy height and closure in the plot, slope, ground cover, soil

appearance, and any other relevant information.

In all tree enumerations done in the course of this study, multiple branches (branching below breast height) were measured individually and recorded as a group; stems clearly arising from the same base were treated in the same way. Where stems were separated at ground level by more than 3-4 cm, they were treated as separate individuals.

Information on growth rates and the relationship between girth and absolute age in tropical trees is almost entirely lacking. The use here of high-precision dendrometers on large samples of trees for studies of seasonal cambial activity presented an opportunity to attempt to study growth rates as well.

The technique used involves the determination of the annual girth (or basal area) increment of each tree of a given species, which is then plotted against the starting basal area of that tree; this provides a rough growth curve for the species considered. The five species for which sample sizes were large enough to attempt this procedure were Antiaris africana, Diospyros abyssinica, Drypetes floribunda, Drypetes parvifolia, and Lannea nigritana. As pointed out earlier, banded trees included a wide range of sizes.

The success of the approach, which has been used previously in temperate forests (Karnig and Stout 1969),

depends in particular on whether an annual growth cycle (and hence an identifiable maximum or minimum for the year) can be discerned; this depends in turn upon the similarity of the seasonal growth pattern from one tree to the next, and on the importance of random fluctuations or sampling error in the pattern. Part of this problem can be resolved by pooling the girth change data, at each sampling period, of all members of the species, and relying upon mean girth changes to elucidate the annual cycle. Calculation of confidence limits about each mean can then permit inferences to be made concerning the probable validity of particular maxima or minima.

In addition, growth data should ideally be collected over a number of years, so that a realistic mean annual increment is obtained. Hence, the usefulness of a single year's record might depend on that year being "typical" in terms of moisture, temperature, disturbance, and so on.

Allometric growth of the crown and trunk was examined in five species of trees, namely Antiaris africana, Lannea nigritana, Diospyros abyssinica, Drypetes floribunda, and Drypetes parvifolia. This was done in order to assess the relationship between the relative growth of crown against trunk and the distribution or habitat preference of different species.

Results

Seedling Studies

A total of 1,931 seedlings belonging to 53 species were tagged during the period of observations.

The density of seedlings varied from one plot to the next (Fig. 42). These differences can generally be explained in terms of the canopy characteristics above the plot (Table 9). In exposed plots, the density was fairly low but showed wide fluctuations with time, while sheltered, well-shaded plots had higher densities which were stable with time. The level of disturbance to seedlings during the two-year period appeared to be fairly high (Fig. 42 and Table 9): there were six instances of disturbance in the 11 plots (55 m² area) which clearly resulted in seedling deaths; these included natural tree falls, cutting of firewood (thicket clump plots only), soil disturbance by termites, and uprooting of seedlings by animals, possibly monkeys (these seedlings were pulled up by the roots and left on the soil surface; the creatures responsible may have been attracted by the bright blue tags which they bore).

The seedling density also varied seasonally (Figs. 42 and 43). Maximum density coincided with periods of very high rainfall (April-July). A rapid increase in numbers

Figure 42

Mean seedling density (number m^{-2}) in each of the 11 sample plots during the two-year observation period. Means based on five $1 m^2$ replicates. Samples are at two-month intervals. Plot 1, at forest margin (north) (animals uprooted seedlings at time shown by arrow); Plot 2, 60 m from forest margin (north), in partly sheltered gap; Plot 3, 120 m from forest margin (north); Plot 4, 195 m from forest margin (north) (termite activity in plot indicated by arrow); Plot 5, 255 m from forest margin (south); Plot 6, 210 m from forest margin (south); Plot 7, 180 m from forest margin (south), in relatively open gap (termite activity in plot indicated by arrow); Plot 8, 135 m from forest margin (south). Plot T₁, thicket clump with sparse canopy (large Millettia thonningii tree felled at time indicated by arrow); Plot T₂, thicket clump with closed canopy; Plot T₃, thicket clump with partly open canopy (cutting of firewood in plot done at time shown by arrow).

Seedlings
m⁻²

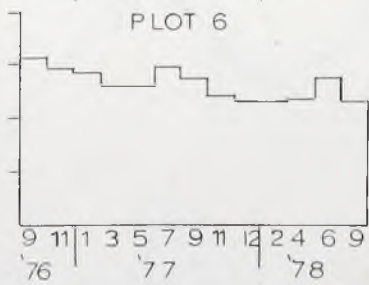
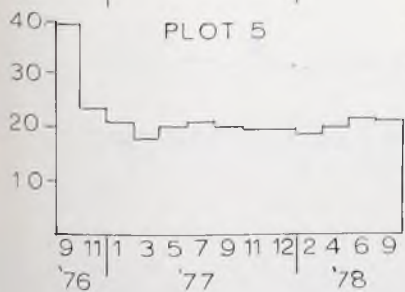
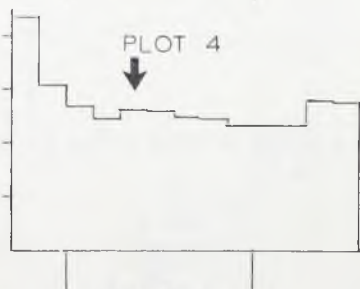
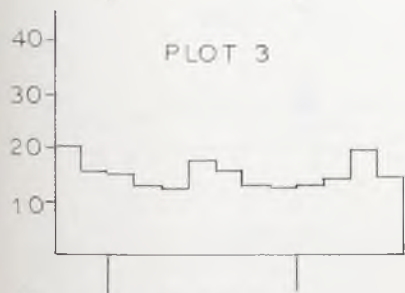
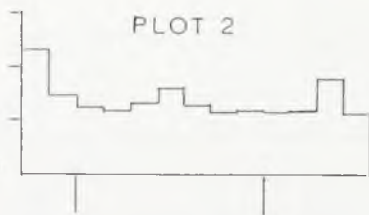
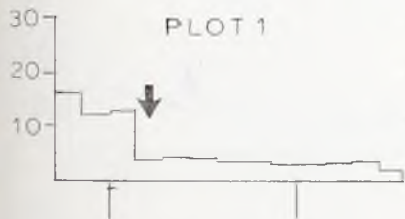

Seedlings

m^{-2}

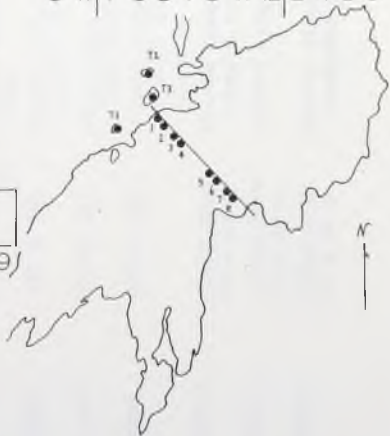
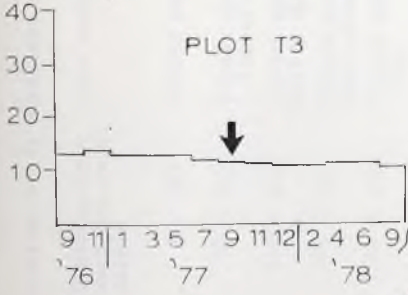
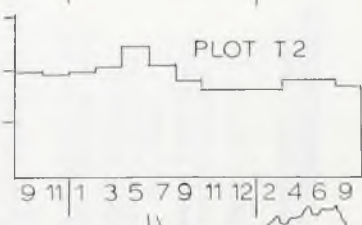
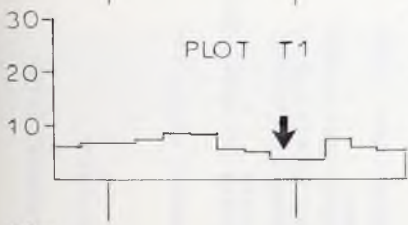
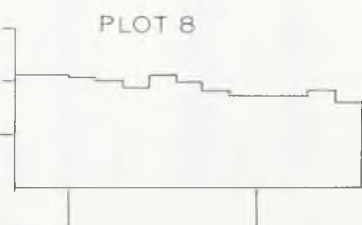
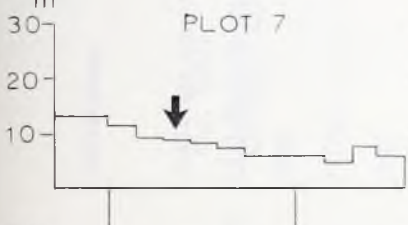

Summary of characteristics of 11 permanent seedling plots

Plot no.	Forest or thicket	Distance from north or south margin	Plot description	Disturbance
1	Forest	5 m (n)	Closed canopy, rather low	Seedlings uprooted, Mar. 1977.
2	Forest	60 m (n)	Partly shaded gap from wind-thrown tree	<u>Millettia thonningii</u> fell in storm, May 1977.
3	Forest	120 m (n)	Closed canopy, deciduous; partly open in dry season	None
4	Forest	195 m (n)	Closed canopy over sloping high ground.	Termite activity, May 1977
5	Forest	255 m (s)	Closed canopy, near large gap	None
6	Forest	210 m (s)	Partly closed canopy, mostly climbers	None
7	Forest	180 m (s)	Large gap, covered by leafless woody climber stems	Termite activity, May 1977
8	Forest	135 m (s)	Closed canopy overhead, rather low; exposed to light on one side	None
T1	Thicket	Clump size 15 x 10 m	Sparse canopy over large, eroded termite mound	<u>Millettia thonningii</u> felled Dec. 1977
T2	Thicket	Clump size 20 x 10 m	Closed canopy, rather low	None
T3	Thicket	Clump size 25 x 20 m	Partly closed canopy under emergent <u>Antiaris africana</u>	Firewood cutting, Sept. 1977

Total density of seedlings (number per 40 m^2) in the permanent seedling plots during the two-year period of observations. Middle curve, species diversity (Shannon's index H'). Top curve, species evenness, calculated as $\frac{1/C}{e^{H'}}$, where C is Simpson's index, H' is Shannon's index, and e is the base of natural logarithms. Left-hand diagram, forest plots; right-hand diagram, thicket clump plots.

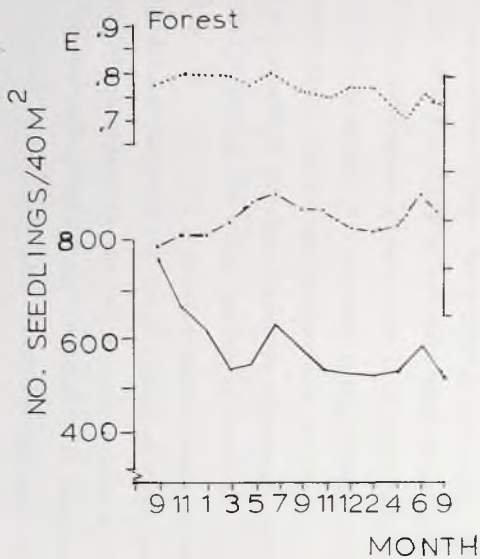

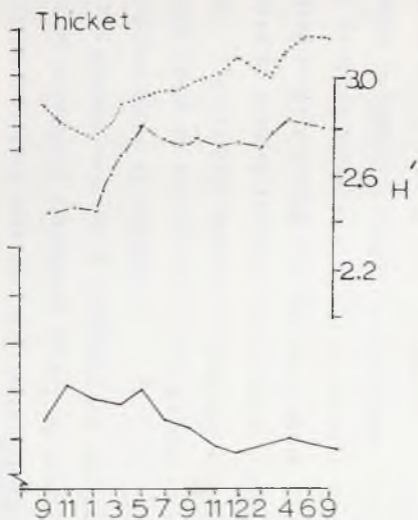

occurred within that period, followed by a gradual, steady decrease in numbers through the dry season. There was, apart from the seasonal cycling, an overall decrease in seedling density during the two-year period; this might be expected in view of the very low rainfall recorded over that period. The seedling density in the thicket clump plots followed the same trend as that in the forest plots, although the density was lower in thicket.

The highest density of seedlings was recorded in the first assessment (September 1976); most of the seedlings comprising this peak were of the climber Calycobolus heudelotii, and the majority of these subsequently perished. The wet season of 1976 had a higher rainfall than the previous year (or the two subsequent years), and this might have contributed to the heavy seedling crop in that year, either by increasing seed production, increasing germination, or both.

The pattern of species diversity (Shannon's index H') of seedlings during the study period is shown in Fig. 43 and Table 10). The diversity maxima coincide with seedling density maxima: the large number of newly germinated seedlings which appear in the wet season include a large number of species as well. As the density of seedlings begins to drop due to mortality under increasingly dry

Density, diversity, and evenness of forest and thicket seedling populations, 1976-1978.

Assessment date	No. seedlings		No. species		Diversity H'				Evenness	
	/40 m ²		For. (40m ²)	Th. (15m ²)	For.	Th.	t (d.f.)	P <	For.	Th.
	For.	Th.								
Sept. 1976	760	443	19	18	2.249	2.419	2.195 (244)	0.05	0.771	0.744
Nov.	655	501	20	21	2.322	2.475	1.911 (278)	N.S.	0.799	0.692
Jan. 1977	621	483	20	21	2.323	2.469	1.743 (265)	N.S.	0.798	0.684
Mar.	544	469	20	23	2.378	2.685	3.970 (299)	0.001	0.789	0.739
May	548	507	22	25	2.467	2.816	4.741 (349)	0.001	0.782	0.753
July	624	445	21	23	2.493	2.763	3.685 (263)	0.001	0.791	0.773
Sept.	581	437	21	23	2.444	2.765	4.316 (284)	0.001	0.767	0.777
Nov.	541	389	21	23	2.400	2.724	4.056 (256)	0.001	0.750	0.802
Dec.	535	376	21	23	2.373	2.731	4.536 (250)	0.001	0.754	0.830
Feb. 1978	530	379	20	23	2.361	2.733	4.668 (248)	0.001	0.755	0.816
Apr.	535	397	21	24	2.374	2.840	6.205 (297)	0.001	0.733	0.854
June	581	387	24	23	2.506	2.823	4.310 (151)	0.001	0.750	0.871
Sept.	517	381	22	23	2.390	2.800	5.030 (280)	0.001	0.736	0.868

conditions, some species are eliminated as well, bringing about a decrease in diversity. This pattern is seen in both forest and thicket clump plots.

It will be observed that the overall density of seedlings is lower, and the diversity higher, in the thicket clump plots than in the forest plots (Fig. 43 and Table 10). The difference in seedling diversity between the two habitats was tested, for each assessment period, using a t-test (Hutcheson 1970); the difference was found to be significant in all but two of the assessments.

If the thinning of seedlings following the density peak of the wet season were random and not influenced by competition or differential survivorship among species, then the probability of a seedling of a given species dying should be proportional to the abundance of that species; in other words, the more abundant species should lose more seedlings. This would bring about an increase in evenness (or equitability) of species representation. Conversely, thinning which is influenced by competitive interactions should result in a reduction of evenness, as those species having a superior competitive ability would tend to increase in dominance to the detriment of other species. The seasonal pattern of seedling evenness is plotted above density and diversity in Fig. 43.

Evenness was calculated as $E_{2,1} = \frac{1/C}{e^{H'}}$, where C is Simpson's diversity index, H' is Shannon's index, and e is the base of natural logarithms (Hill 1974). The evenness in forest plots follows a general decline with decreasing density, suggesting that competition may be important. The evenness in thicket plots, on the other hand, increases with decreasing density, suggesting that random thinning, rather than competition, is important. This is consistent with the observation that density is lower in the thicket plots.

While the density fluctuations of seedlings in the various plots tended to show fairly comparable seasonal patterns, the density of individual species, and their relative distribution in forest versus thicket plots, showed a variety of patterns (Fig. 44). The trees Drypetes floribunda, Dichapetalum guineense, and Diospyros abyssinica and the climbers Strychnos usambarensis and Uvaria ovata showed little change in numbers during the observation period. Drypetes parvifolia and Dialium guineense (trees) and Asparagus warneckei (a climber) all showed a regular seasonal cycle, with increases in abundance in June-July, and maintained their numbers from year to year. Erythroxylum emarginatum, Clausena anisata, and Antiaris africana (trees) and Calycobolus heudelotii and

Standing crop of seedlings in each species during the two-year study period. Left-hand side, forest; right-hand side, thicket. Counts given for area of 40 m² in each habitat.

(a) Trees (15 species): Df, Drypetes floribunda; Om, Ocina membranacea; Tv, Teclea verdoorniana; Ff, Flacourtia flavescens; Ln, Lannea nigritana; Cha a, Chaetacme aristata; Dp, Drypetes parvifolia; Ee, Erythroxylum emarginatum; Dic g, Dichapetalum guineense; Dia g, Dialium guineense; Da, Diospyros abyssinica; Cla a, Clausena anisata; Aa, Antiaris africana; Da, Diospyros mespiliformis; Mt, Millettia thonningii.

(b) Shrubs (4 species): Ck, Chassalia kolly; Bc, Byrsocarpus coccineus; Pc, Pavetta corymbosa; Sv, Securinega virosa.

(c) Climbers (18 species): Ha, Hippocratea africana; As, Acridocarpus smeathmannii; Gm, Grewia megalocarpa; Ds, Dracaena surculosa; Jp, Jasminum pauciflorum; Cal h, Calycobolus heudelotii; Uo, Uvaria ovata; Al, Adenia lobata; Aw, Asparagus warneckeii; Im, Ipomoea mauritiana; Su, Strychnos usambarensis; Can h, Canthium horizontale; Rr, Ritchiea reflexa; Cc, Capparis erythrocarpos; Gs, Griffonia simplicifolia; Gc, Grewia carpinifolia; Tf, Tiliacora funifera; Ts, Triclisia subcordata.

SEEDLINGS

20 -



Df



Om



Tv



20 -

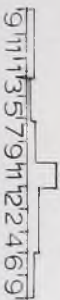

Ff

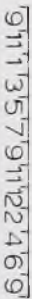

996

TREES

Forest

Thicket



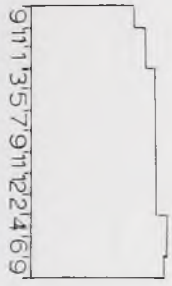
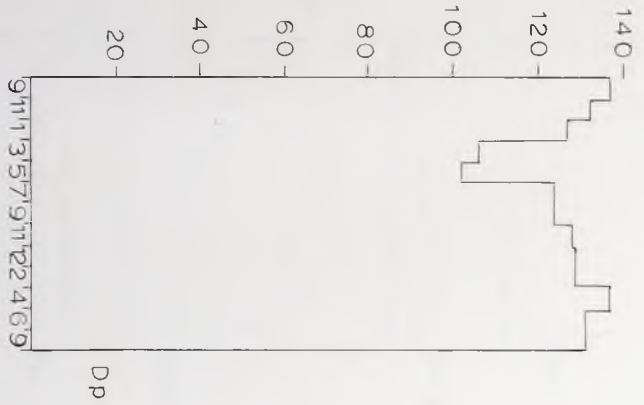
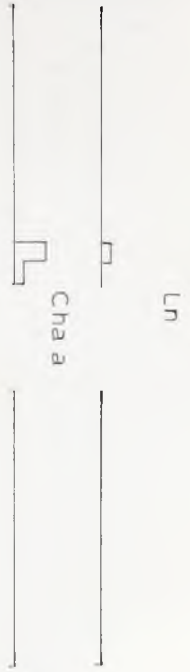

SEEDLINGS



Da

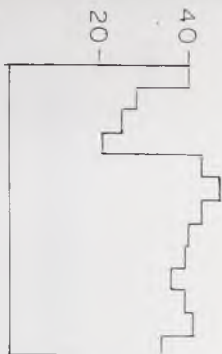

Dia g



Dic g

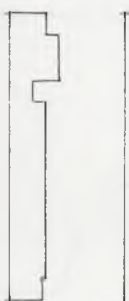
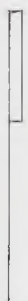
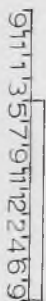

99 x

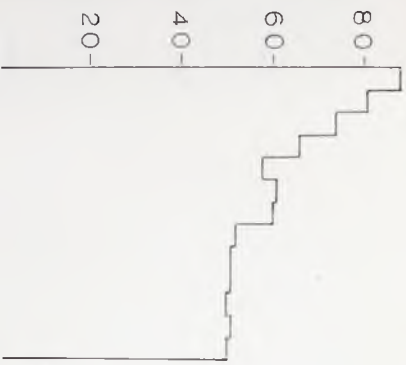

Ee



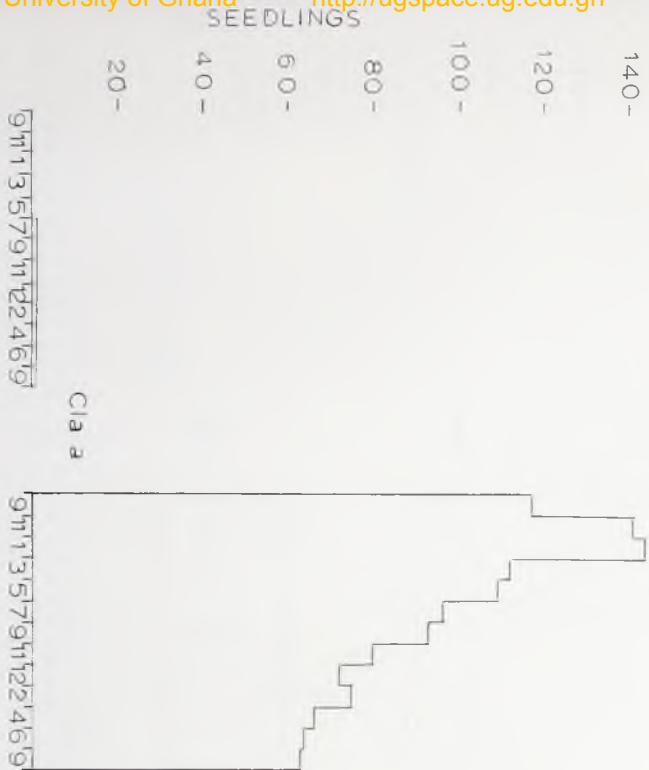

a b

SEEDLINGS

40 -

20 -

20 -



Dm



Mt

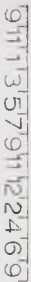

99f

40—
20—

AD



SHRUBS

Forest

Thicket

20-

Ck

40-

20-

Bc

20-

Pc

40-

20-

SV

SEEDLINGS

9 11 13 57 9 11 12 24 69

9 11 13 5 7 9 11 12 24 6 9

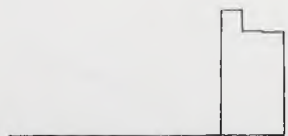
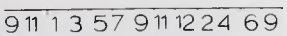
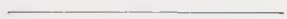
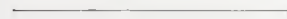
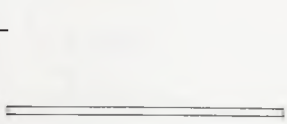

CLIMBERS

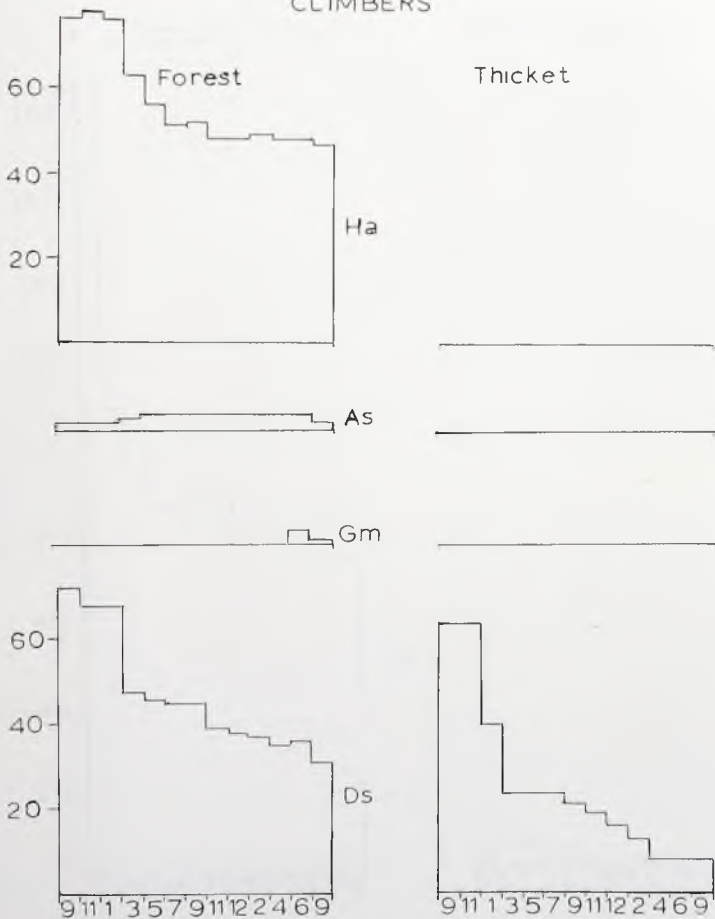



SEEDLINGS



99

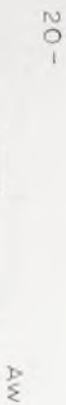

SEEDLINGS

20 -

20 -



Gs



Gc



Tf



Ts

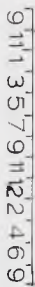
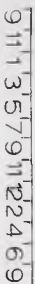

99k

20 -



Rr



40 -



Ce



Hippocratea africana (climbers) showed a steady decline in numbers; all these species except Antiaris africana showed a small-amplitude seasonal cycle (indicating some recruitment) impressed upon this overall decline. These species generally had rather few recruits, however, compared with the other species.

The seasonal pattern of seedling recruitment and mortality was found to vary between species and between years (Fig. 45). In most species, both recruitment and mortality were higher in the first year (1976-77) than in the second year (1977-78). In the first year, most of the recruitment occurred in March-July among the tree species, and was somewhat earlier, in November-March, among many of the climbers. An exception to this is Adenia lobata, a fleshy climber which produced large numbers of seedlings regularly each June-July and lost them all during the subsequent two months. Most of the mortality took place in the driest part of the year, between November and February, although mortality in the semi-climbing shrub Dracaena surculosa was highest in March, at a time when most of the new seedlings had reached the age of six months.

In the second year, recruitment was generally lower, later, and spread over a longer period. This may have occurred because the rainfall was never high enough to

Pattern of recruitment and mortality of seedlings during the two-year study period. Recruitment and mortality in each two-month interval expressed as the percent of the total for the species. Eleven species (five trees and six climbers) are considered: Ee, Erythroxylum emarginatum; Dia g, Dialium guineense; Da, Diospyros abyssinica; Dp, Drypetes parvifolia; Df, Drypetes floribunda; Al, Adenia lobata; Cal h, Calycobolus heudelotii; Can h, Canthium horizontale; Ha, Hippocratea africana; Aw, Asparagus warneckei; Ds, Dracaena surculosa.

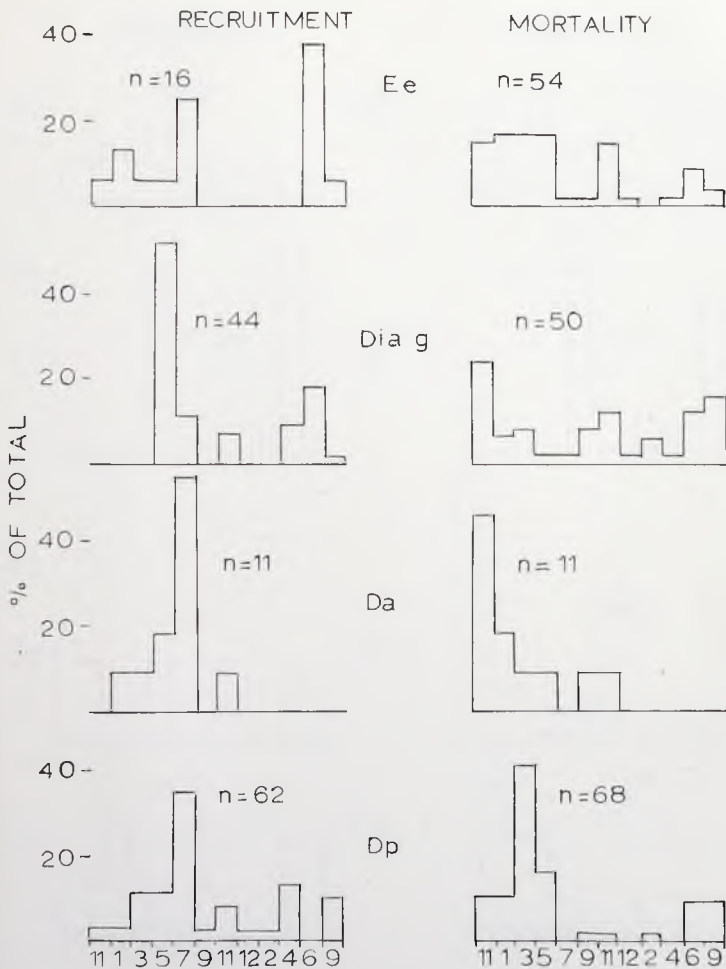

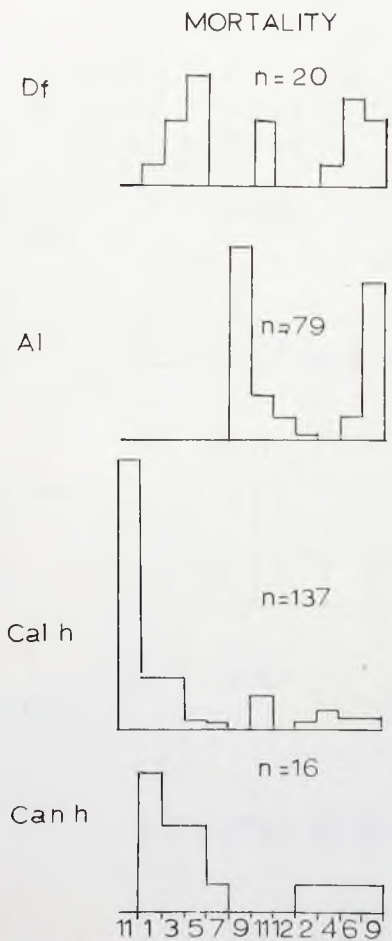
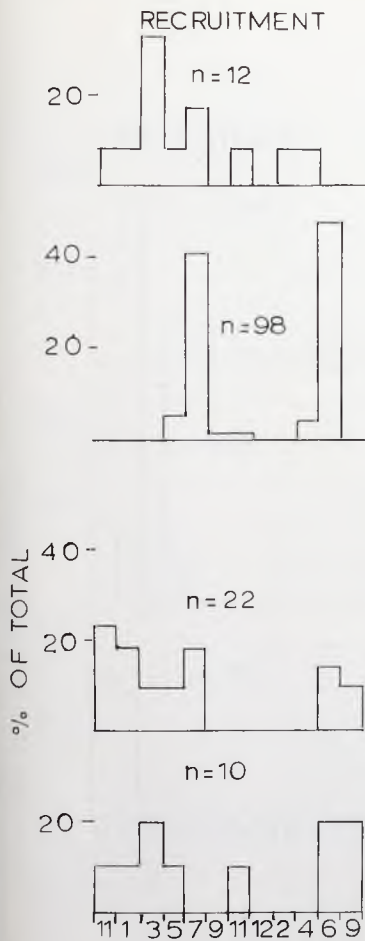

ly

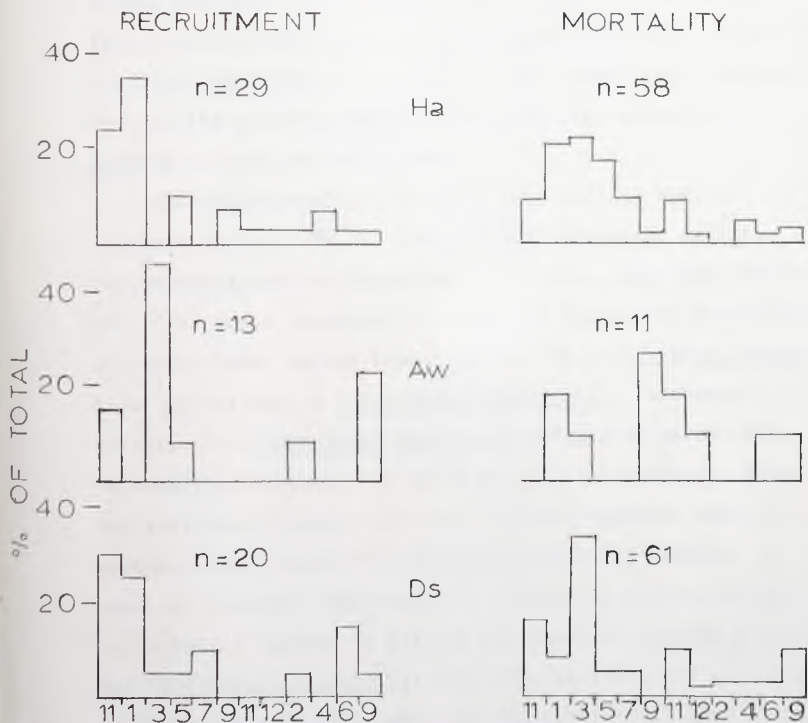

produce a well-defined seedling peak, and seedlings might have germinated rather sporadically in the absence of a strong stimulus; or, alternatively, could have resulted from sporadic seed set, also due to poor rainfall. Mortality was also lower and more diffuse in the second year, perhaps because the seedling density was never high enough to produce a clear mortality peak.

The height-specific mortality of seedling species is shown in Fig. 46 . This presents mortality data as the percentage of all seedlings in a given size class which die. The total mortality of seedlings during the first year of observations varied from a low of 19% in Drypetes floribunda to a high of 56% in Calycobolus heudelotii. Although mortality in Calycobolus heudelotii dropped to around 35% in seedlings between 5-22 cm in height, the mortality rate was still much higher than that in other species; this is a species which regenerates quite successfully, however, by means of abundant root suckers. Mortality curves appeared to be fairly regular in all but two species, Dialium guineense and Calycobolus heudelotii; the first of these had a comparatively small sample size (67), and sampling error could have led to the apparent fluctuations in height-specific mortality in this species.

Height-specific mortality curves for seedlings of six species (four trees, two climbers). Species abbreviations, Sample size, and total seedling mortality rates \pm 95% confidence limits are as follows: Df, Drypetes floribunda, n = 40, M = 19 \pm 7.1%; Dia g, Dialium guineense, n = 65, M = 35 \pm 12.9%; Ec, Erythroxylum emarginatum, n = 80, M = 35 \pm 9.9%; Ha, Hippocratea africana, n = 93, M = 46 \pm 10.0%; Hp, Drypetes parvifolia, n = 320, M = 53 \pm 5.7%; Cal h, Calycobolus Keudelotii, n = 200, M = 56 \pm 7.0%. (Curves fitted by eye).

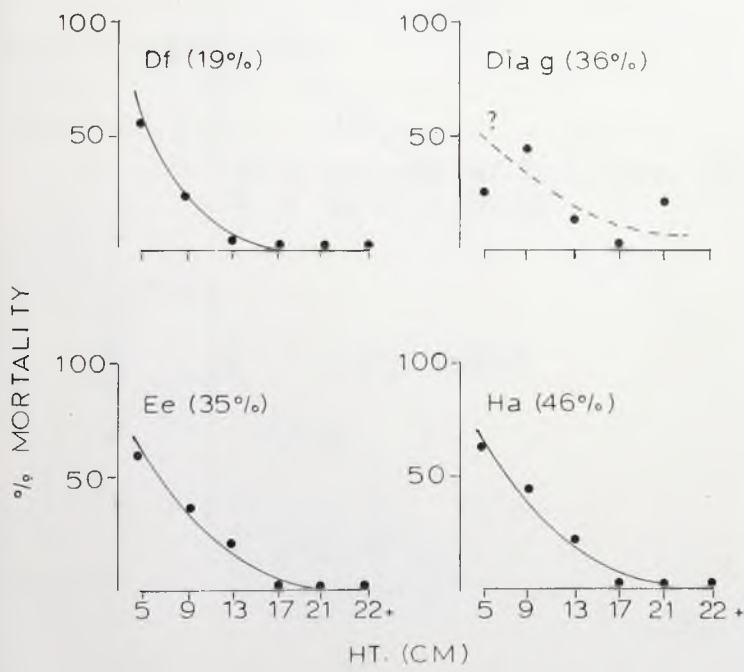

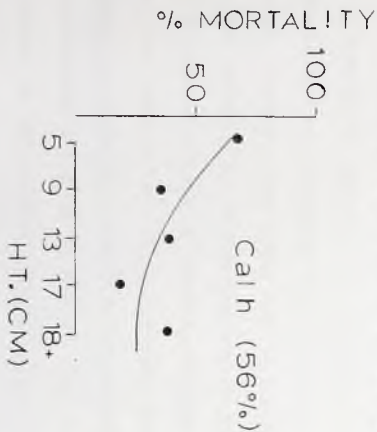

101e

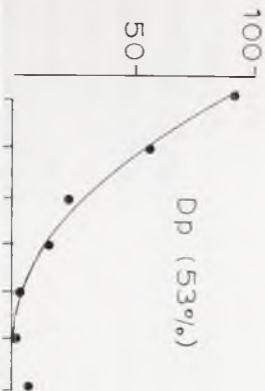

Growth curves were estimated on the basis of passage time from one size class to the next for seedlings of four species, including one climber (Hippocratea africana) and three trees (Erythroxylum emarginatum, Drypetes floribunda, and Drypetes parvifolia). The estimated curves of height for age are plotted in Fig. 47 . (Other species were not considered for analysis, either because they had too few members in each size class, or were represented in too few size classes). Because of the problem of sample size, the estimates of age for the largest size classes are necessarily less reliable than those for the smallest classes; however, the error may be relatively small, as regular curves with little scatter of points were obtained.

The growth rates of these seedlings appear to be quite slow; the species for which the best data are available, Drypetes parvifolia, showed an estimated growth rate of approximately 0.5 m in 20 years! The fastest growth rate was shown by the climber, Hippocratea africana, which attained a height of 18-21 cm in less than 6 years. The other species attained that height in an estimated 7 years (Drypetes floribunda), 7.5 years (Erythroxylum emarginatum), and 9 years (Drypetes parvifolia).

Growth rates of forest species measured in the field do not normally exhibit smooth curves of the kind estimated

Estimated growth curves for seedlings of four species (one climber and three trees), based on passage time from one size class to the next. Species abbreviations as follows: Ha, Hippocratea africana; Ee, Erythroxylum emarginatum; Df, Drypetes floribunda; Dp, Drypetes parvifolia. (Curves were fitted by eye).

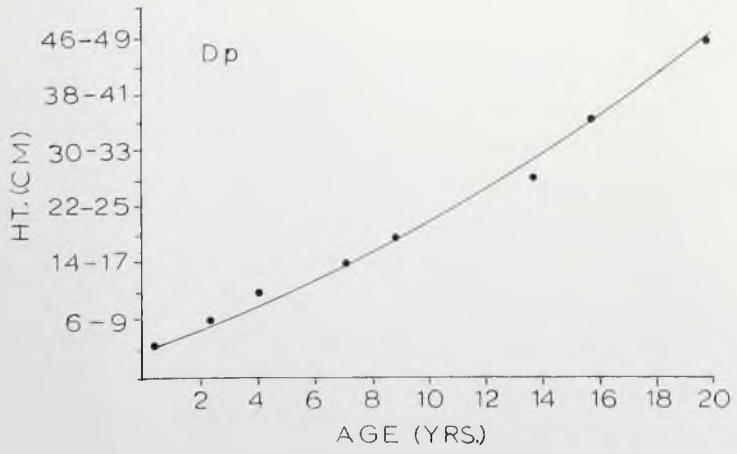
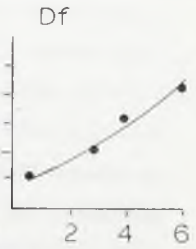
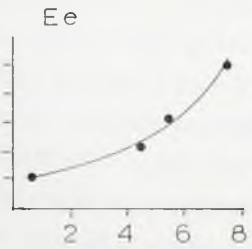
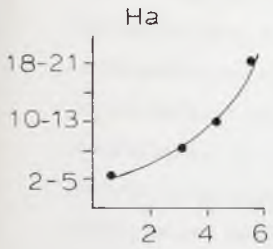

here; rather, growth is often sporadic, depending upon the availability of resources such as light or water, or upon stresses such as herbivore damage. The measurements upon which these growth curves are based were made during a period of very low rainfall, and for this reason must be interpreted as minimal growth rates - a lower growth limit which obtains under particularly unfavourable climatic conditions. In view of this point, the differences in growth rates shown by these four species may represent differential drought tolerance rather than the normal differences in their growth rates.

Soil Seed Stocks

In two experiments described under Methods, the seed content of soils collected from four sources was assessed; the sources were unburnt and recently burnt grassland, a thicket clump, and closed-canopy forest.

In the first experiment, soil samples were collected from grassland and the thicket clump, and these were watered to encourage germination. In this experiment, the soil samples were each divided in half, one part being placed in full sunlight and the other in artificial shade.

Results from this experiment are presented in Table 11. No seedlings germinated from the shaded soil samples, and so they are not included in the table. The seed content of unburnt and burnt grassland soils appeared to be very similar; a total of 298 and 254 seedlings, respectively, germinated from these samples; over 95% of them being grasses and the remaining few being small forbs. The burnt sample had fewer species (6) than did the unburnt sample (8), and had a lower value of Shannon's diversity index H' (0.189) than the unburnt sample (0.315).

The thicket clump soil sample produced far fewer seedlings (80), with more species (23) and higher diversity

Seedlings germinating from grassland and thicket soil samples; soil collected from area of 0.5 m² to depth of 0.05 m, and germinated in full sunlight.

Species (Habitat)		Source of soil		
		Unburnt grassland	Burnt grassland	Thicket clump
<u>Sporobolus pyramidalis</u>	(G)	281	246	9
<u>Heteropogon contortus</u>	(G)	4	2	
<u>Borreria scabra</u>	(G)	6	2	2
<u>Phyllanthus sublanatus</u>	(G)	3	2	
<u>Cassia mimosoides</u>	(G)	1		
<u>Digitaria ?leptorachis</u>	(G)	1		
<u>Fimbristylis sp.</u>	(G)	1		
<u>Mariscus sp.</u>	(?TG)			
<u>Tephrosia elegans</u>	(G)		1	
<u>Dactyloctenium aegyptium</u>	(G)		1	
<u>Ipomoea mauritiana</u>	(TF)			19
<u>Solenostemon monostachyus</u>	(T)			17
<u>Securinega virosa</u>	(TG)			9
<u>Setaria barbata</u>	(TF)			4
<u>Premna quadrifolia</u>	(TF)			3
<u>Commelina erecta</u>	(G)			2
<u>Galactia sp.</u>	(G)			1

Species (Habitat) ^a	Source of soil		
	Unburnt grassland	Burnt grassland	Thicket clump
<u>Brachiaria</u> sp. (G)			1
<u>Panicum maximum</u> (G)			1
<u>Vigna reticulata</u> (G)			1
<u>Ehretia cymosa</u> (TG)			1
<u>Morinda lucida</u> (TG)			1
<u>Mariscus alternifolius</u> (TG)			1
<u>Trema orientalis</u> (T)			1
<u>Parquetina nigrescens</u> (T)			1
<u>Abrus precatorius</u> (T)			1
<u>Ruellia praetermissa</u> (T)			1
<u>Tragia</u> sp. (TF)			1
<u>Adenia lobata</u> (TF)			1
<u>Chaetacme aristata</u> (TF)			1
<u>Uvaria ovata</u> (TF)			1
Total seedlings	298	254	80
Total species	8	6	23
Woody (%)	0	0	39
Species diversity (H')	0.315	0.189	2.441

^aG, Grassland; T, Thicket; F, Forest.

(2.441) than either of the grassland soil samples. Of these seedlings, only 19% were grasses, 30% were small forbs, and around half the seedlings were of woody species.

In a second experiment, soil samples were collected from three plots within the forest

and placed in full sunlight, with regular watering; comparable plots under forest canopy were demarcated, cleared of seedlings, and left unwatered.

Table 12 shows the results of this experiment.

(Each of the three sunlit samples is comparable to each of the samples in the last experiment, in terms of soil volume collected and the treatment given.) The sunlit forest soil samples yielded very few seedlings (58 in the three samples pooled) and species (8 in the pooled samples), and an H value of diversity (1.531), compared with the thicket or the grassland soil samples. The shaded forest samples had even fewer seedlings (23 in the three samples pooled), approximately the same number of species (9), and a higher diversity value (1.994) than the sunlit samples. Only 3% of the seedlings in the sunlit forest soil sample were grasses, and none of those germinating under the forest canopy were grasses. Most of the seedlings in both the treatments were woody

Seedlings germinating from three pairs of forest soil samples; soil collected from area of 0.5 m² to depth of 0.05 m; one sample in each pair was germinated in full sunlight, the other in situ under the forest canopy

Species	(Habitat) ^a	Light regime							
		Sunlight				Shade			
		1	2	3	Tot.	1	2	3	Tot.
<u>Securinega virosa</u>	(TG)	16	1		17		1		1
<u>Trema orientalis</u>	(T)	4	1	6	11				
Unidentified sedge	(?F)	1		21	22			3	3
Unidentified grass	(?G)	2			2				
<u>Adenia lobata</u>	(TF)	2			2	1	3	1	5
<u>Afraegle paniculata</u>	(F)	1			1				
<u>Drypetes parvifolia</u>	(F)		1		1			2	2
<u>Elytraria lyrata</u>	(F)						2		2
<u>Chaetacme aristata</u>	(TF)						2		2
<u>Asparagus warneckeii</u>	(TF)						1		1
Unidentified dicot.	1 (-)						1	5	6
Unidentified dicot.	2 (-)		2		2				
Total seedlings					58				23
Total species					8				9
Woody (%)					62				56
Species diversity (H')					1.531				1.994

^aG, Grassland; T, Thicket; F, Forest.

species; while two of the most numerous species are typically found in thicket, the remaining species all occur in closed-canopy forest.

In order to assess the extent of inter-habitat mixing in the seed rain, species present in soil from each of the three habitats (the two grassland samples were pooled) were classified in terms of their usual habitat as adults, and a contingency table was constructed from this information (Table 13). There was a highly significant positive association between the source of the soil in which a seedling appeared and the usual habitat of the adult members of the species ($G = 42.04$, 4 d.f.; $P < 0.005$). This would suggest that there is considerable within-habitat constancy in the delivery of seeds to the soil.

Four kinds of seed-dispersal mechanisms were represented among species which germinated from the soil samples: animal dispersal (12 species, including 11 which are eaten by mammals or birds and one with adhesive fruits); explosive dispersal (3 species, all of them small herbs); wind dispersal (2 species); and, the most numerous group, 20 species which had no obvious seed dispersal mechanism. Most of these were small-seeded grasses, sedges, and forbs which may have their seeds dispersed in mud on animal hooves (J.B. Hall, pers. comm.).

Table 13

Two-way classification of species which germinated from soil samples, based on the source of the soil in which the seedlings appeared and the usual habitat of the adults of the species; each species in each soil sample was classified ($G = 42.04$, 4 d.f.; $P < 0.005$).

Source of soil	Usual adult habitat			
	Grassland	Thicket	Forest	Total
Grassland	9	0	0	9
Thicket	7	16	0	23
Forest	1	2	7	10
Total	17	18	7	42

Species which germinated from soils of suitable and unsuitable habitats (defined in terms of occurrence of adults in the habitat) (see Table 13) were then classified as to seed dispersal mechanism, in order to test the association between intra- or extra-habitat dispersal and the dispersal mechanism. Table 14 shows the two-way classification; no significant association was demonstrated ($G = 5.460$, 3 d.f.; $0.1 < P < 0.5$). The effectiveness with which seeds are delivered to appropriate habitats thus appears to be comparably high with all types of dispersal mechanisms found in these species. The sample sizes of species having wind-dispersed and explosively-dispersed seeds were admittedly quite small, however the result obtained was not unduly biased by these categories: a similar conclusion was reached when these categories were either omitted or were pooled with the "no dispersal mechanism" group.

Table 14

Two-way classification of species which germinated from soil samples, based on the suitability of the habitat from which the seed germinated and the seed dispersal mechanism. There is no demonstrable association between these parameters ($G = 5.460$, 3 d.f.; $0.1 < P < 0.5$).

Habitat	Dispersal mechanism				Total
	None ^a	Animal	Explosive	Wind	
Habitat suitable	12	10	3	2	27
Habitat unsuitable	8	2	0	0	10
Total	20	12	3	2	37

^aPossibly dispersed in mud (see text).

Vegetative Regeneration

During the first year of seedling observations (1976-77), a number of 1 m^2 quadrats were placed in forest and thicket clumps each month, and all seedlings within them harvested; these were later sorted and counted (see Methods). Because the plants were uprooted, it was possible to distinguish with certainty between seedlings and root suckers. This information was used in a comparison of the frequency of reproduction by the two methods in each of the species collected.

The number of quadrats harvested during the year was over 150. This was considered to be an unnecessarily large sample for the comparison envisaged and for this reason, a random subsample of 30 quadrats from each habitat was taken from the records (selection was random in terms of both location and sampling time).

Table 15 shows the frequency of seedlings and root suckers of each species in samples from the two habitats. Trees and shrubs, as a group, show relatively little root sucker production compared with seedling production; the proportion of suckers is higher, however,

Frequency of regeneration by seedlings and root suckers in forest and thicket clumps (30 quadrats of 1 m² placed in each habitat; production of epicormics in adult plants noted.

Species	FOREST		THICKET		epicormic shoots ^a
	seedlings	root suckers	seedlings	root suckers	
TREES AND SHRUBS					
<i>Lannea nigritana</i>		6			-
<i>Teclea verdoorniana</i>	4				+
<i>Ochna membranacea</i>	4				-
<i>Chaetacme aristata</i>	2				++
<i>Drypetes parvifolia</i>	167		1		++
<i>Drypetes floribunda</i>	49		1		++
<i>Dialium guineense</i>	43		2		(+)
<i>Erythroxylum emarginatum</i>	125		12		+
<i>Diospyros abyssinica</i>	6		4		(+)
<i>Dichapetalum guineense</i>	4	3	5	7	+
<i>Afraegle paniculata</i>	3		1	2	+

Species	FOREST	
	seedlings	root suckers

<i>Millettia thonningii</i>		2
<i>Pavetta corymbosa</i>	2	
<i>Chassalia kolly</i>	4	
<i>Vepris heterophylla</i>	1	
<i>Coffea ebracteolata</i>		
<i>Carissa edulis</i>		
<i>Diospyros mespiliformis</i>		
<i>Malacantha alnifolia</i>		
<i>Byrsocarpus coccineus</i>		
TOTAL	414	11
	(97%)	(31)

THICKET		epicormic shoots ^a
seedlings	root suckers	
3		++
4		n.a.
15	1	n.a.
2		+
2		n.a.
2		n.a.
2		(+)
3		+
13		n.a.
72	10	
(88%)	(12%)	

Species	FOREST	
	seedlings	root suckers
CLIMBERS		
<i>Hippocratea africana</i>	52	2
<i>Strychnos usambarensis</i>	15	3
<i>Calycobolus heudelotii</i>	295	99
<i>Dracaena surculosa</i>	73	13
<i>Acridocarpus smeathmannii</i>	7	1
<i>Uvaria ovata</i>	42	10
<i>Canthium horizontale</i>	39	4
<i>Jasminum pauciflorum</i>	11	4
<i>Asparagus warneckei</i>	5	
<i>Tiliacora funifera</i>		2
<i>Capparis erythrocarpos</i>	1	
<i>Secamone afzelii</i>		1
<i>Triclisia subcordata</i>		1
<i>Ritchiea reflexa</i>	1	1

THICKET		epicormic shoots ^a
seedlings	root suckers	
		+
		+
16		-
11	1	-
1	1	+
13	8	++
40	15	?-
10	17	++
4		-
	1	+
1	1	++
1	1	+
	2	+
4		+

108c

Species	FOREST		THICKET		epicormic shoots ^a
	seedlings	root suckers	seedlings	root suckers	
<i>Griffonia simplicifolia</i>	5		21	5	++
<i>Cremaspora triflora</i>	4		26	4	+
<i>Tragia</i> sp.	1		14	4	?-
<i>Grewia carpinifolia</i>			2	3	+
TOTAL	551 (80%)	141 (20%)	164 (72%)	63 (28%)	

^aepicormics indicated as follows: +, basal or epicormic shoots develop spontaneously; ++, such shoots develop abundantly; (+), such shoots arise only following injury; -, such shoots never seen.

in thicket (12%) than in forest (3%) ($\chi^2 = 15.980$, 1 d.f.; $P < 0.001$). Root sucker production is more important among climbers than it is in trees ($\chi^2 = 80.46$, 1 d.f.; $P < 0.001$), although seedlings still outnumber root suckers. Again, the importance of root suckers is higher in thicket (28%) than in forest (20%) ($\chi^2 = 5.387$, 1 d.f.; $P < 0.025$).

It is interesting to note that, among the trees and shrubs, both forms of offspring - root suckers and seedlings - were found to occur in only 3 species out of 20 (15%), while in climbers 15 species out of 18 (83%) had both seedlings and root suckers. Most of the species which produce both showed relatively even proportions of the two, although suckers were, on the whole, slightly rarer.

The production of epicormics and basal shoots (shoots from buds on or near the base of the stem) is important in both trees (67% of species) and climbers (77% of species), and occurs in those species with high seedling production as well as those with high root sucker production. The production of basal shoots appears to be the only significant mode of regeneration found at present

in Chaetacme aristata in Pinkwae; seedlings of this species are rare and generally die soon after germination. Some of the larger trees (Diospyros abyssinica, Diospyros mespiliformis, and Dialium guineense) produce basal shoots only following injury to the stem, while most of the climbers and many of the trees produce basal shoots or epicormic branches spontaneously. Uvaria ovata and Capparis erythrocarpos characteristically develop enormous numbers of vigorous climbing shoots from a single base. A number of climbers, particularly the rather slender species Secamone afzelii, Jasminum pauciflorum, and Calycobolus heudelotii, differentiate roots and shoots from stems which lie on the ground; this type of propagation, termed layering, does not seem to be as important as root sucker production in the regeneration of these species.

Size Class Distributions

Size class frequency distributions were compiled for 13 tree species occurring in Pinkwae. Information was collected from two sets of enumerations: first, the 37 sample plots of 0.01 ha each (total 0.37 ha), which were described under Methods in this section; and second, a mapped plot of 0.36 ha which is described in a later section dealing with species dispersion patterns. The total area of the enumerations was thus 0.73 ha, this area being well-distributed throughout the forest (see Fig. 5b). It was felt that the series of 0.01 ha plots constituted an adequate sample for three of the most abundant species (Drypetes parvifolia, Drypetes floribunda, and Diospyros abyssinica), and the data from the map enumeration were therefore not used in compiling size class distributions for these three species.

Basal area class distributions of the 13 tree species are shown as histograms in Fig. 48 a-m. The basal area class intervals used differ between species; the choice of intervals for each species was based on the range of sizes represented in the species, and was intended to provide an adequate number of well-represented classes.

Basal area class distribution of trees in 13 species: (a) Drypetes parvifolia; (b) Drypetes floribunda; (c) Diospyros abyssinica; (d) Lannea nigritana; (e) Erythroxylum emarginatum; (f) Dialium guineense; (g) Vepris heterophylla; (h) Ochna membranacea (i) Chaetacme aristata; (j) Dichapetalum guineense; (k) Cassipourea congoensis; (l) Millettia thonningii; and (m) Baphia nitida. The first "basal area" class is seedlings or (in the case of Lannea nigritana) root suckers less than 1 m in height. Inset is plot of basal area class against log-transformed frequency. (basal area classes are the same, in each case, as those used in the histogram).



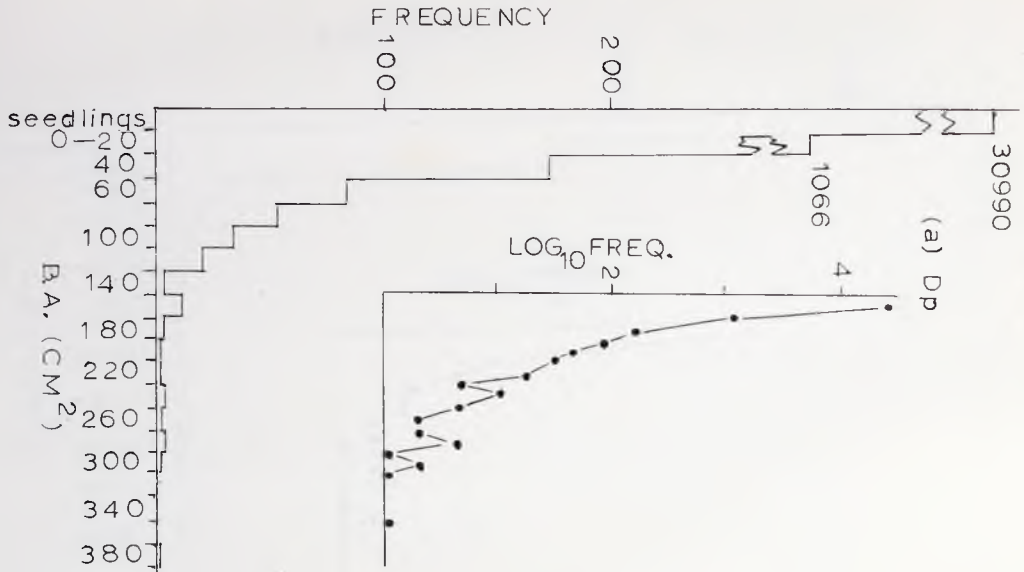

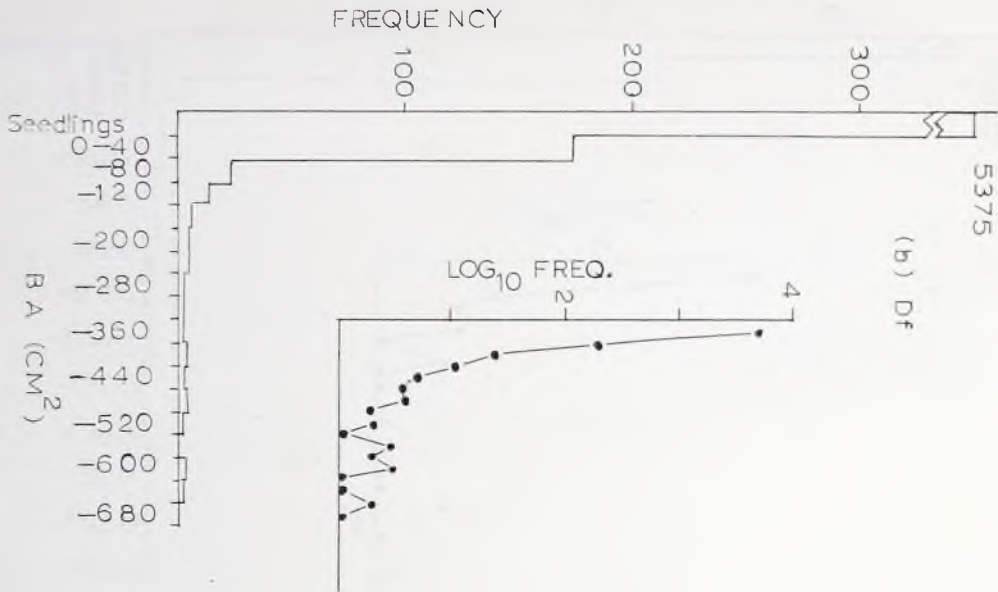

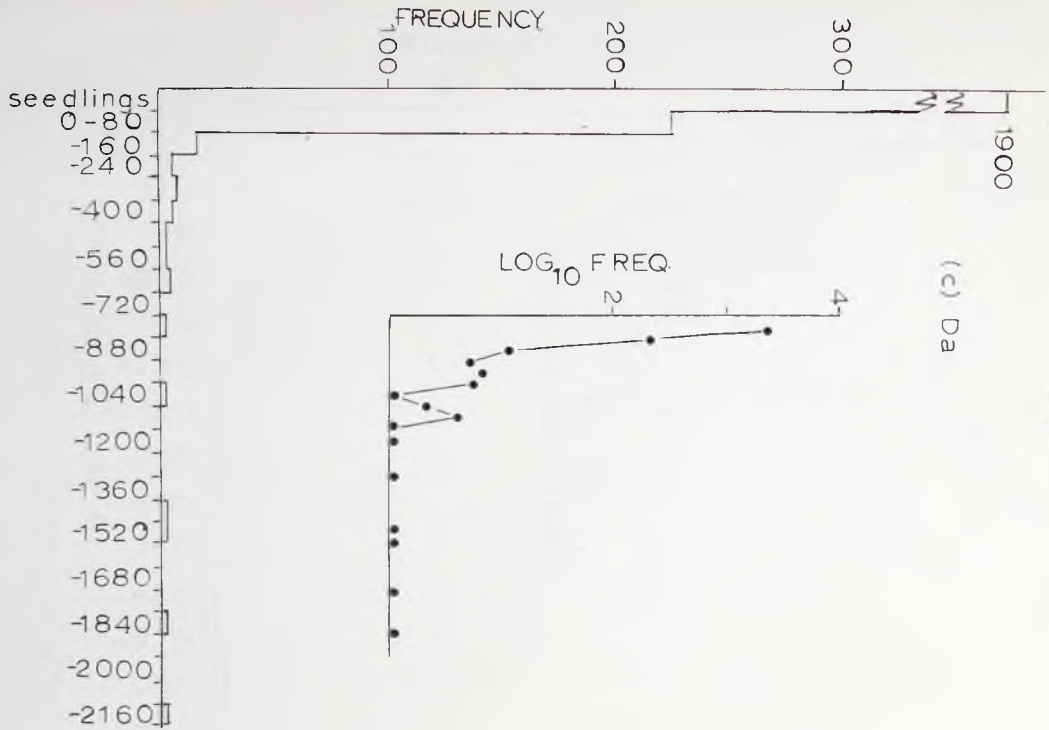

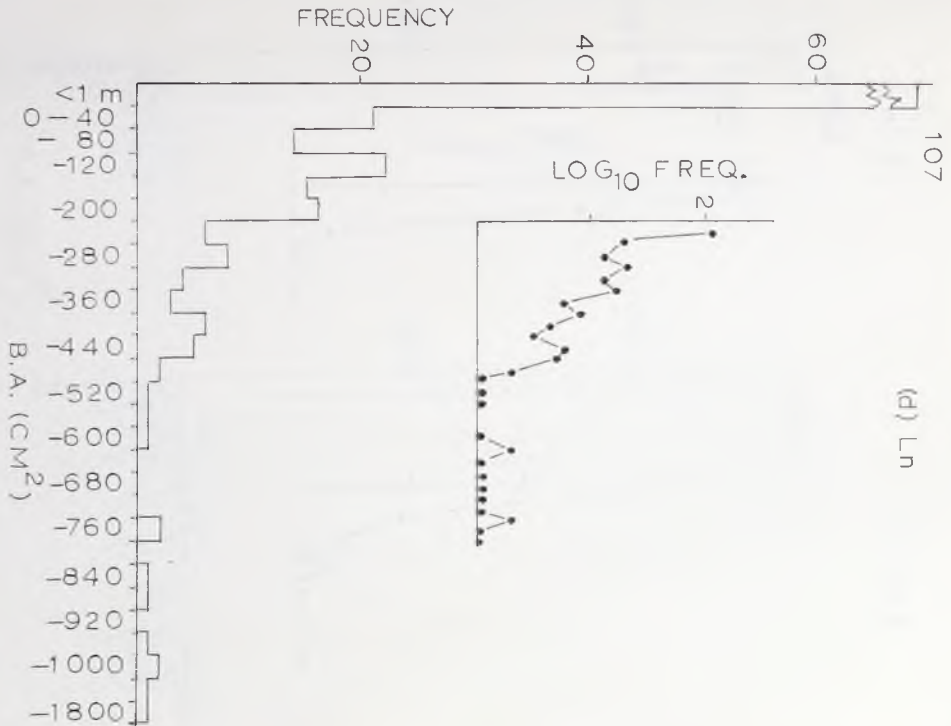

(d) Ln

111e

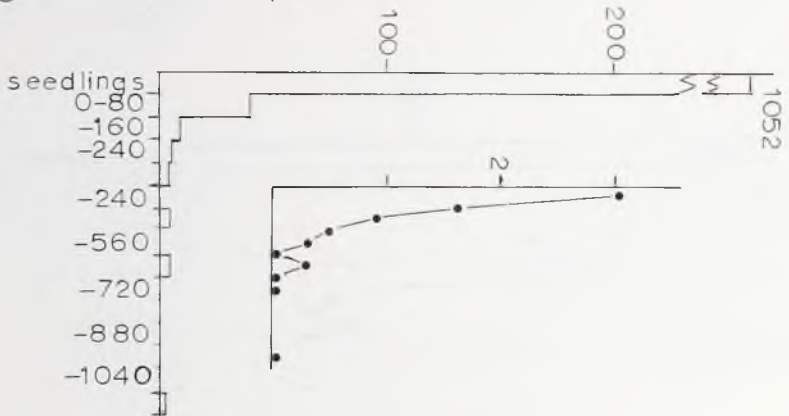
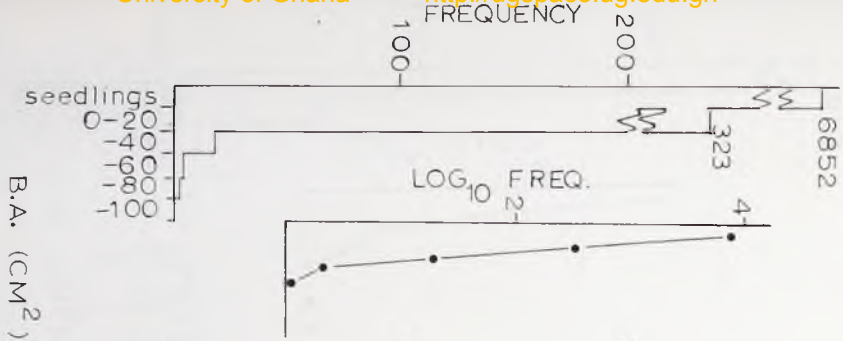

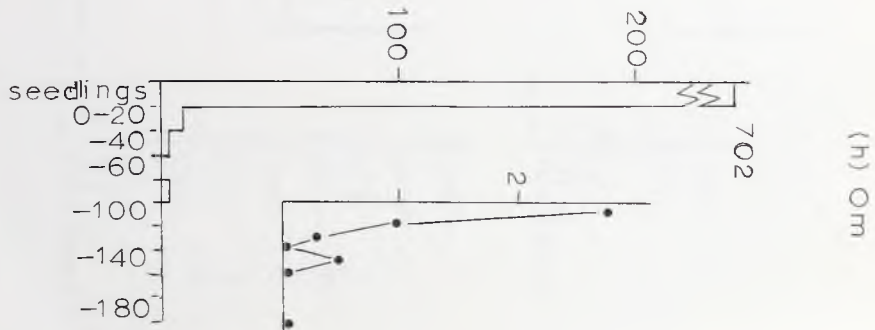
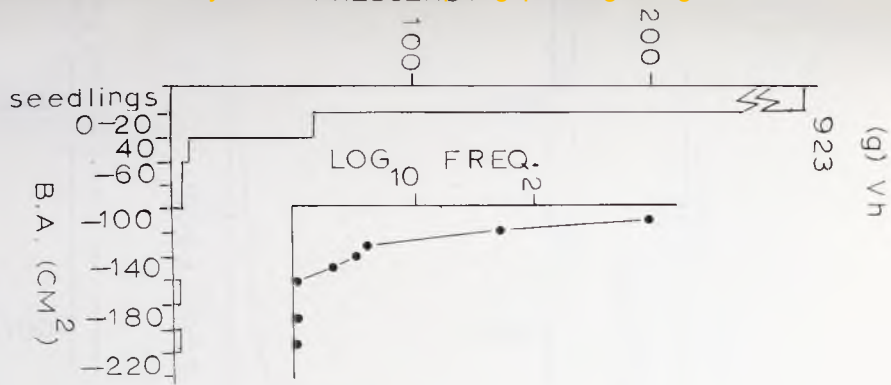

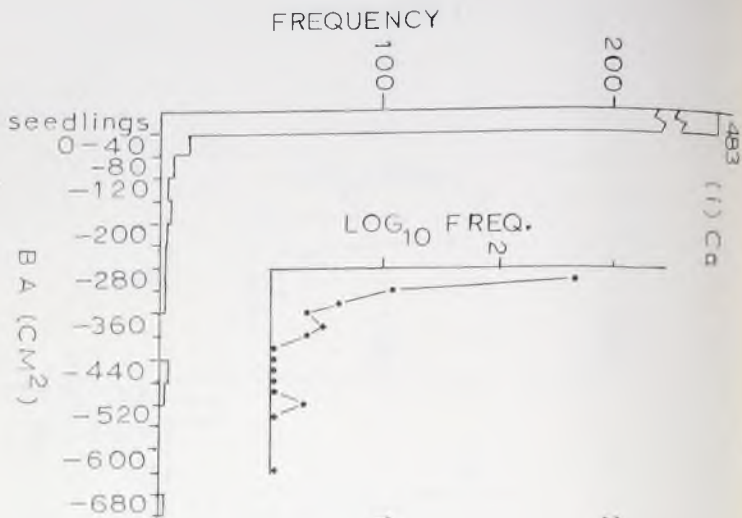

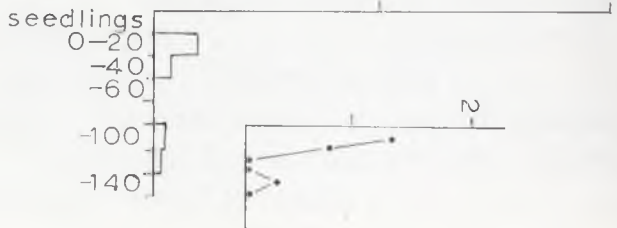
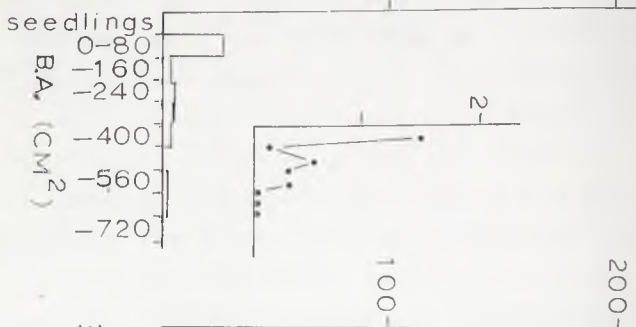
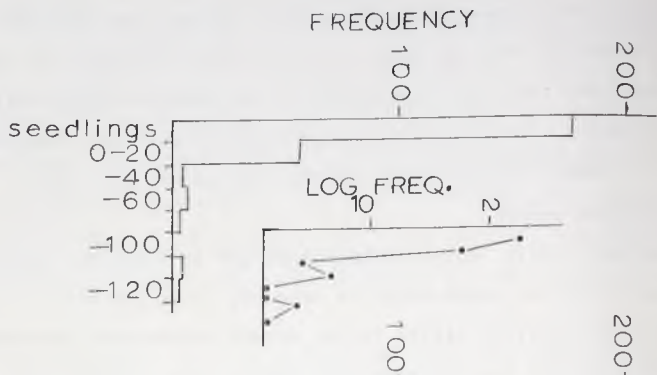

(K) Cc

(L) Dd

(M) Bn

Intervals were 20 cm² in Drypetes parvifolia, Erythroxylum emarginatum, Vepris heterophylla, Ochna membranacea, Dichapetalum guineense, Cassipourea congoensis, and Baphia nitida; 40 cm² in Drypetes floribunda, Lannea nigritana, and Chaetacme aristata; and 80 cm² in Diospyros abyssinica, Dialium guineense, and Millettia thonningii. For the purposes of this analysis, seedlings of less than 1 m height were taken to be a single size class, and all other classes were defined by equal basal area increments.

It appears that most of the species considered show good stocking in all size classes. There are three exceptions to this. Two of the rarest species, Millettia thonningii (l) and Baphia nitida (m), lacked seedlings entirely (or root suckers less than 1 m in height). The lack of seedling stages in the sample is probably not due to chance, as these would be expected to be the most numerous class, but is more likely due to a genuine rarity of these stages.

Lannea nigritana (d) departs strikingly from the frequency distribution patterns shown by the other species. There are very few individuals in the smallest size class, as compared with the number in other species; those in the sample were invariably root suckers rather than seedlings.

The general survivorship from one size class to the next, viewed over the plot as a whole, appears rather high. Most interesting, however, is the suggestion of an irregular, cyclical pattern in the size distribution, indicating the possibility of episodic pulses of fecundity, mortality, or growth events. There are, if the present crop of suckers is taken to be a pulse, six apparent pulses, although only four of these are pronounced; these four have maxima in the following basal area classes: suckers; 0-120 cm²; 360-400 cm²; and 720-760 cm². A one-tailed runs test (Sokal and Rohlf 1969) on the pattern of positive and negative deviations from expected frequencies demonstrated that it is unlikely that the observed pulses could be due to sampling error ($P < 0.05$) (Table 16). Because of its interest, further studies on Lannea nigritana were undertaken; these are reported in the following section.

It is not being assumed here that size class reflects age class. Within even-aged, single-species stands, size differences develop rapidly due to genetic differences, site differences, and competitive suppression of some trees by others (Hozumi et al. 1968); in a natural multiple-aged mixed species forest, one can expect to find only a very weak relationship between size and age. In perennial plants, however, many parameters of population dynamics

One-tailed runs test for dichotomized data; test of the null hypothesis that the sequence of positive and negative deviations from the expected frequencies in Lansea nigritana size classes is random. Expected frequencies calculated from the linear regression line (for log-transformed frequencies) $y = -0.00145x + 1.297$ ($r = -0.857$, 21 d.f.; $P < 0.01$).

B.A. class (cm ²)	Observed frequency	Expected frequency	Deviation from expectation
< 1 m ht.	107	19.8	+
0-40 cm ²	21	17.3	+
-80	14	15.2	-
-120	22	13.3	+
-160	15	11.6	+
-200	16	10.2	+
-240	6	8.9	-
-280	8	7.8	+
-320	4	6.8	-
-360	3	6.0	-
-400	6	5.2	+
-440	5	4.6	+
-480	2	4.0	-
-520	1	3.5	-
-560	1	3.1	-

B.A. class (cm^2)	Observed frequency	Expected frequency	Deviation from expectation
-600	1	2.7	-
-640	0	2.3	-
-680	0	2.0	-
-720	0	1.8	-
-760	2	1.6	+
-800	0	1.4	-
-840	1	1.2	-
-880	1	1.1	-
-920	0	0.9	-
-960	1	0.8	+
-1000	2	0.7	+
-1040	1	0.6	+
-1080	1	0.5	+

n_1 = no. of positive deviations = 13

n_2 = no. of negative deviations = 15

r = no. of runs = 11

The probability of finding this few (11) or fewer runs due to chance is less than 0.05; the null hypothesis is therefore rejected.

(reproductive behaviour, for example) tend to be size-specific and not age-specific, and the size distribution may therefore be of interest in its own right (Harper 1977, p. 601).

A plot of the basal area class versus the logarithm of the frequency is inset with each figure. This semi-log plot permits a better visual assessment of the shape of the curve, particularly in the smaller, more numerous size classes. Regions of linearity on the semi-log plot indicate intervals of size in which the probability of surviving is a constant function of the number of trees present; that is, a constant fraction of the number present survive, independent of size. (It should be re-emphasized here that the intervals are based on size, and not necessarily on age.)

It is possible to estimate the survivorship rate (the probability of a tree surviving to enter the next size class) within regions of linearity on the plot by means of a simple linear regression; if the regression slope of the semi-log plot is b , then the value 10^b is the proportion which will enter the next size class, or, put another way, will be equal to the probability of surviving to the next size class. The value 10^b , which is analogous to the finite

rate of increase of a population (Birch 1948), is equal to the ratio of the number of trees present in class $x + 1$ to the number in the next smaller class x ; or $N(x+1)/N(x)$. (Use of this approach requires the assumption that the size distribution is stable.) Because the number of trees decreases in succeeding size classes, the regression slope b will be negative, and the value 10^b will be less than one. The plot is based directly on cm^2 of basal area, and the survivorship rate thus generated will be the probability of surviving to the next increment (1 cm^2) of basal area. The calculated slopes and survivorship rates are therefore independent of the basal area interval used to define class limits in the plot.

It is apparent from inspection of the semi-log plots that there are at least three distinguishable patterns of size-specific survivorship. In Erythroxylum emarginatum (e) and Dichapetalum guineense (j), the survivorship curve has only one phase; there is no change in the survivorship rate as trees progress from the seedling stage to the largest adult size classes. A second type of pattern may be seen in Drypetes floribunda (b), Diospyros abyssinica (c), Vepris heterophylla (g), Chaetacme aristata (i), and Cassipourea congoensis (k); in these species, there is an initial phase of low survivorship which is followed, after

a sharp inflection, by a phase of higher survivorship in the larger classes. Thus, for these species, the probability of surviving to the next size class improves with increasing size. In a third group, the shift from the very steep slope in small size classes to the more level slope in larger classes is gradual, and not marked by an abrupt inflection point; species of this type were Dialium guineense (f) and Ochna membranacea (h). It is felt likely that the absence of a strong inflection in the survivorship rate of these species is not an artifact of sampling, but may be characteristic of the species (at least under the growth conditions which obtain here).

A fourth group of species, Drypetes parvifolia and Lannea nigritana, showed evidence for three more-or-less discrete regions in the plot; these species may more properly belong to either the second or third group defined above, but because it was possible to resolve an intermediate region in these species they were grouped together for convenience. The very large sample size in Drypetes parvifolia undoubtedly contributed to the resolution of this intermediate area; it is possible that an intermediate phase could also be present, but be obscured, in some of the less abundant species. Two rare species in the samples, Millettia thonningii

and Baphia nitida, had very small sample sizes and few well-represented size classes, and for this reason could not be satisfactorily placed in one of the above groups. Table 17 shows the calculated survivorship rates (10^0) for each species. Those species having a constant slope have a single value. Those in which the slope appears to change with increasing size were divided into two (or three) regions, over each of which a separate slope was calculated. In the second group of species, the inflection point was easily discerned by inspection: the plot for Drypetes floribunda (b), for example, is taken to have an inflection point at around 160 cm^2 of basal area; before that size the survivorship rate is very low, and for trees larger than that size the survivorship rate is improved. For species in the third group, which lacked an abrupt inflection point, the delineation of regions over which slopes were to be calculated had to be rather arbitrary; this was also the case in the species having three defined regions of slope. In the two very rare species it was not possible to define separate regions of the plot with any certitude, and for this reason a single slope was calculated over the full size range of the species; the resulting value of the survivorship rate is therefore excessively high for the smallest classes.

Estimated size-specific survivorship rates of 13 tree species; species are grouped according to the pattern of survivorship over the size range of the species:

(1) single-phase; (2) two-phase with a sharp inflection; (3) two-phase with a gradual inflection; (4) three-phase; and (5) two rare species with patterns which could not be classified.

Species	Sample size		Survivorship (10 ^b)	Applicable range of b.a. (cm ²)	Canopy position ^c
	Seedlings < 1 m height	Trees + Saplings > 1 m height			
(Group 1)					
<u>Dichapetalum guineense</u>	395	56	.9290	0-140	Us-L
<u>Erythroxylum emarginatum</u>	6,852	344	.8913	0-80	US
(Group 2)					
<u>Diospyros abyssinica</u> ^a	1,900	268	.9750	0-240	Cn-Em
			.9908	240-2,160	
<u>Drypetes floribunda</u> ^a	5,375	240	.9594	0-160	Cn
			.9979	160-640	
<u>Chaetacme aristata</u>	483	30	.9572	0-120	Us-4
			.9988	120-680	

Species	Sample size		Survivorship (10 ^b)	Applicable range of b.a. (cm ²)	Canopy position ^c
	Seedlings < 1 m height	Trees + Saplings ≥ 1 m height			
<u>Cassipourea congoensis</u>	176	66	.8933	0-40	
			.9886	40-140	L-Cn
<u>Vepris heterophylla</u>	923	71	.8730	0-40	
			.9931	40-200	Us-L
(Group 3)					
<u>Dialium guineense</u>	1,054	57	.9772	0-240	
			.9991	240-1,120	Em
<u>Ochna membranacea</u>	702	15	.8630	0-40	
			.9886	40-180	US
(Group 4)					
<u>Lannea nigritana</u>	107 ^b	134	.9750	0-80	
			.9954	80-480	Cn-Em
			.9998	480-1080	
<u>Drypetes parvifolia</u> ^a	30,990	1,462	.8790	0-40	
			.9750	40-120	L-Cn
			.9908	120-380	

Species	Sample size		Survivorship (10 ^b)	Applicable range of b.a. (cm ²)	Canopy position ^c
	Seedlings < 1 m height	Trees + Saplings ≥ 1 m height			
(Group 5)					
<u>Millettia thonningii</u>	0	38	.9954	0-1,120	Em
<u>Baphia nitida</u>	0	22	.9750	0-120	Us

a enumerations of these species based on 0.37 ha; all others based on .73 ha.

b all members of this size class were root suckers.

c abbreviations as follows: Us, understory; L, lower part of canopy; Cn, canopy;

Em, emergent.

It is clear that within the region of the larger size classes, the fit of the regression line begins to deteriorate; this is due to the small number of trees in those size classes, and the resulting sampling errors (it is not possible, for example, to observe in the field $1/3$ or $1/5$ of a tree, although that may be the expected number in one of the larger size classes). These discrepancies are further amplified because of the logarithmic scale. Nonetheless, the resolution obtained is considered to be adequate for comparative purposes.

The 13 species in Table 17 are grouped first according to the type of survivorship pattern: single phase; two-phase with a sharp inflection; two-phase with a gradual inflection; three-phase; and lastly, the rare species which had less reliable survivorship estimates. Within each group, the species are then ranked in order of the survivorship rate of the smallest classes, those with the highest survivorship rates being first. (The survivorship rates defined for the largest size classes did not vary widely between species, and were therefore disregarded in the ranking.)

Within each of the species groups, the calculated survivorship rate (small sizes) is closely related to the

typical position of the species in the canopy, trees of greater potential stature having the highest early survivorship rates. In the first group (single-phase survivorship), Erythroxylum emarginatum, an understorey tree or shrub which seldom attains 4 m in height, has a lower estimated rate of survivorship than Dichapetalum guineense, a somewhat larger tree. Neither of these single-phase species normally reach the height of the canopy.

In the two-phase (strong inflection) group, Diospyros abyssinica, an emergent species, has the highest survivorship rate, followed by Drypetes floribunda, a fairly large canopy species. The remaining species (Chaetacme aristata, Cassipourea congoensis, and Vepris heterophylla) range from the understorey to the lower canopy (or rarely mid-canopy), and these have the lowest rates of survivorship in the small size classes.

The pattern is repeated in the remaining three sections: the emergent trees Dialium guineense, Lannea nigritana, and Millettia thonningii have higher survivorship rates than the understorey and lower canopy species Ochna membranacea, Drypetes parvifolia, and Baphia nitida.

Because the survivorship rates of the largest size classes are relatively constant from species to species,

it follows that the difference between the two survivorship rates in each species (small sizes versus large sizes) also varies according to the pattern described above; the emergents tend to have greater similarity between their early and late survivorship rates than do understorey trees. The obvious exception to the trend, however, is found in the single-phase species, which have a constant survivorship rate over their full size range, and which are both understorey trees.

The basal area class at which the survival rate inflection for a species occurs appears to be a function of the maximum size which is attained by the species (as defined by the largest recorded tree in the sample). The regression line ($y = 6.4x - 27.9$; $r = 0.893$, 7 d.f.; $P < 0.01$) was calculated using single-phase and two-phase species only; the three-phase species did not appear to be readily applicable to the problem. The two rare species were also omitted. (The "inflection point" in single-phase species was taken to occur at a basal area of 0 cm^2 for purposes of calculation.) The implication of this relationship is that the critical size class at which survivorship begins to improve varies between species, and is in some fashion a property of the species, rather than simply representing the

Inflection Point

point at which the trees reach some critical size in relation to the canopy. Large species tend to show a later inflection point than small species (in terms of size class), and (as mentioned above) this change in rate is less severe in large than in small species. Omitting the single-phase species, it is found that the inflection occurs, on the average, when the trees have reached $20\% \pm 5.6\%$ of their maximum potential size.

Lannea nigritana

Lannea nigritana appears to be regenerating in Pinkwae solely by means of root suckers (Fig. 49). In a permanent seedling plot area of 40 m^2 which was re-assessed at two-month intervals for two years, no seedlings of Lannea were recorded; in 120 m^2 of area which was harvested of all seedlings during a one-year period, no seedlings of Lannea were found; and finally, in a search area of 148 m^2 which was distributed in 37 plots throughout Pinkwae (4 m^2 in each), only two seedlings of Lannea were found. Because of their obvious interest, these seedlings were re-visited so that measurements of their growth might be made; both perished within three weeks, however. This represents a seedling germination rate for the species of around $8 \text{ seedlings ha}^{-1} \text{ yr}^{-1}$, with an establishment rate of nought. In comparison, within the sampling area on which this estimate was based, more than 7,500 seedlings of other species were identified and counted.

In each of the three years of observation, Lannea nigritana produced flowers during the major dry season when the trees were still leafless. Flowering was widespread in the population, and some fruit was set, although only in moderate amounts, in each year. Some of this fruit fell to

Patch of large trees of Lannea nigritana; note characteristic pitted bark. Ground cover mostly root suckers of the climber Calycobolus heudelotii. Climber stems abundant, including Adenia lobata, Strophanthus hispidus, and Capparis erythrocarpos.

Figure 50

Root sucker of Lannea nigritana showing herbivore damage to successive shoots. Scale indicated by metre rule.



the ground directly below the parent trees, and the remainder was probably dispersed by birds. The complete failure of seedling production in this species, therefore, is not simply due to a lack of seeds.

Root suckers are not, on the whole, abundant. The mean density (based on 37 sample plots of 0.01 ha each plus four larger plots totalling 0.33 ha) was 154 suckers ha^{-1} in the 0-1 m height class and 17 suckers ha^{-1} in the 1-3 m height class. The sucker density is, not surprisingly, quite patchy, and high sucker densities are associated with high adult tree densities. Because the four larger plots mentioned above were located (intentionally) in areas of high adult Lannea density, the estimates of mean sucker density are probably too high.

Examination of the root suckers reveals that almost all suckers are damaged by browsing. The shoot morphology indicates the typical sequence of events in the growth of a young sucker (Fig. 50): the shoot grows to a height of 20-40 cm, when the growing tip of the shoot is chewed off, probably by a browsing antelope; a lateral shoot develops a few centimetres below the broken end, and this grows for a period of time until it too is eaten (often the second shoot is eaten before it reaches the height of the first break);

a third lateral shoot develops, and so on. It appears that only the very tender tip of the shoot, with its crown of four or five leaves, is consumed.

In order to assess the extent and nature of the damage to which the young suckers are subjected, measurements were made from ground level to each successive shoot tip on a sample of 34 Lannea root suckers; the suckers used in the sample were the first 34 suckers less than 1 m in height which were encountered in a search area of 625 m². A record was made of the condition of each measured shoot tip (dead or actively growing). The pattern of heights attained by successive shoots (Fig. 51) is evidence of the level of growth suppression which must result from the repeated predation on shoots. All of the 34 root suckers in the sample had been browsed; the number of damaged shoot tips was especially high within the 0-30 cm height range; some suckers produced as many as four or five shoots within this range, each of which was chewed off in turn. A height frequency distribution (based on the highest living meristem) for Lannea root suckers is shown in Fig. 51 ; the distribution shows a comparative paucity of very small suckers, the modal height being around 35 cm. Repeated browsing could artificially maintain a large number of suckers within an intermediate height range and thereby produce the observed

Growth pattern of shoots of Lannea nigritana root suckers subjected to predation by antelope. Eighteen representative suckers are shown: the height of sequential shoots is plotted against the order of the shoot in the sequence. Right-hand side: damaged sucker showing typical growth form (diagrammatic). Live meristems indicated by stars; dead meristems indicated by filled circles.

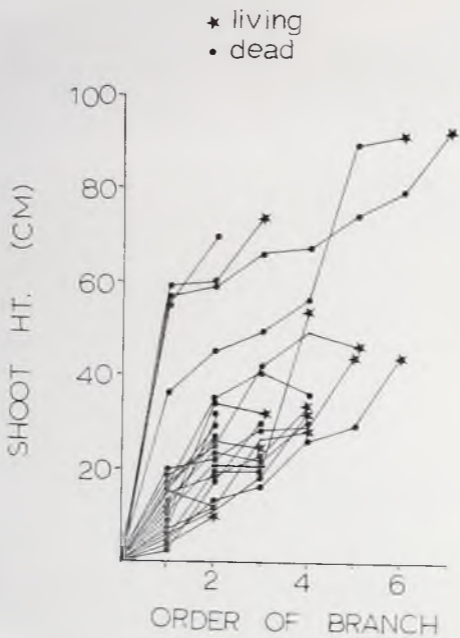

Damaged Lanea
nigritana sucker
(diagrammatic)

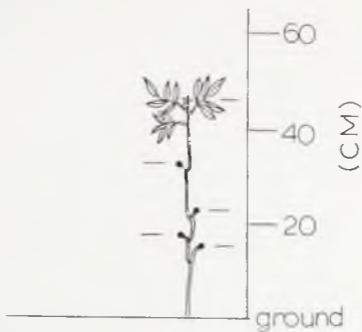

Height distribution of a sample of Lanea nigritana root suckers less than 1 m in height. Height is measured at the highest living meristem.

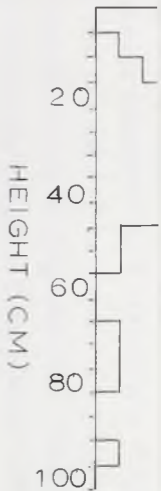

FREQUENCY

5

10



mode. The lack of small individuals in the sample might come about if young suckers were to grow rapidly, using parental resources, the transit time through the small size classes being fairly short as a consequence.

Although browsing on Lannea nigritana suckers was never directly observed, indirect evidence (including tracks and droppings) strongly suggests that bushbuck are responsible. These creatures are nocturnal in their habits, which would explain the lack of observation, and they are quite abundant in the forest. It is likely that other species in which young basal shoots are seen to be browsed (especially Hippocratea africana and Millettia thonningii) are also eaten by bushbuck; of these species, however, Lannea suffers by far the greatest damage.

The overall population size distribution of Lannea nigritana (see Fig. 48 d) was found to have an irregular cyclical component which was impressed upon the normal monotonic decrease in numbers with increasing size. The cycles did not occur at equal size-intervals, but ranged from 120 cm² to around 360 cm²; further, they did not occur at regularly increasing intervals.

The observed pulses could result either from localised, patchy events or from events occurring generally throughout

the forest. In order to evaluate these alternatives, size distributions were compiled for each sample plot separately. The plots considered were 14 of the 0.01 ha plots (the remaining 23 of these plots did not contain Lannea trees), and four larger plots, having a total area of 0.33 ha, in which only this species was girted. The latter four plots were, as mentioned above, located in areas of relatively high Lannea density. It appears from Figure 53 that the inferred irregular episodes in Lannea are not forest-wide or population-wide phenomena, but are attributes of local patches. There are marked differences between plots in the size distribution pattern. Certain plots (4, 28, 31, 35) contain only small individuals, while other plots (32, 27, 25) contain more large than small individuals.

Further, in plots with more than one individual, the dispersion of these individuals with regard to size appears to be clumped; this is the case even in plots with more large than small trees. Plots which have very large individuals, however (27, 25, 9, D), also have small trees, suggesting that, in these plots, root suckers of the large trees have attained the minimum size for inclusion in the record, and are maintaining the clone.

Figure 53

Basal area class distribution of Lannea nigritana in a number of individual sample plots. Left-hand side, 14 plots of 0.01 ha each (plot number indicated at right); right-hand side, 4 larger plots: A, 0.075 ha; B, 0.125 ha; C, 0.0625 ha; and D, 0.070 ha (total area for these four, 0.33 ha).

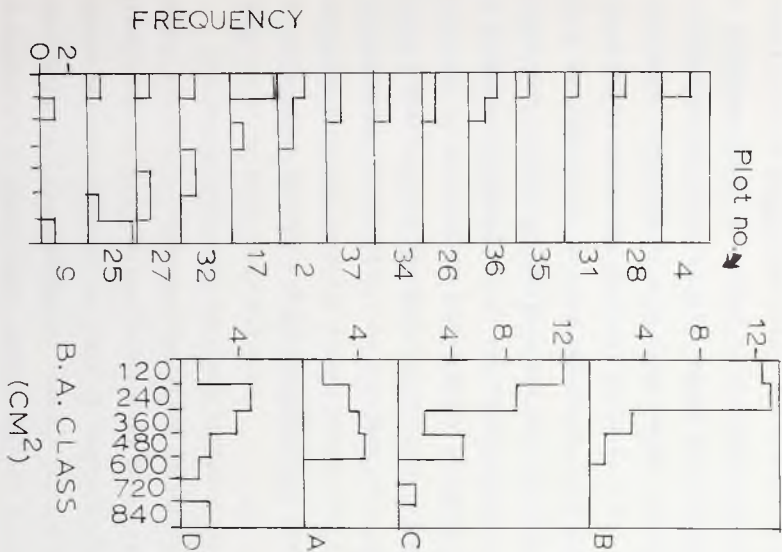

The small size of the 0.01 ha plots in relation to the density of the Lannea population could contribute, by means of sampling error, to trends of the kind observed; however, the four larger plots clearly repeat the pattern of marked inter-plot variation in size distribution and an infra-dispersed size-density pattern; in these plots, sampling error is expected to be less important. For purposes of comparison, a similar analysis was done on size distributions of Drypetes floribunda in 31 individual plots 0.01 ha each; there was no evidence of size-density clumping within plots in this species, and the modal size class was always, with the exception of one plot, the smallest size class. It is concluded that the periodic events which seem to dominate the population dynamics of Lannea nigritana are unevenly distributed in both space and time.

The nature and cause of these irregular events is not known, although certain possibilities appear to be more likely than others. Size-class pulses could result from marked periodic changes in rates of regeneration, mortality of growth, or a combination of these. The principal cause of mortality in small root suckers appears to be predation by bushbuck; while it is conceivable that population cycles of these antelope might occur and bring about cycles of predation pressure on Lannea, such a phenomenon should be

distributed uniformly throughout the forest, and not be restricted to local patches, as are the observed episodes of Lannea abundance. It is unlikely that other potential causes of mortality (such as drought) would be cyclical in occurrence, would affect Lannea but not other species, and would be patchy in their distribution.

This would imply that either regeneration or growth must be episodic. Lannea nigritana achieves its greatest density near gaps, and young individuals are typically found next to paths or in other fairly open situations. Examination of the field notes concerning the 37 sample plots confirms that the plots in which very large Lannea trees were recorded were all in the vicinity of old gaps. Plots having only small Lannea trees either had an uneven and rather low canopy, or the canopy was in fact quite broken-up. There were a few relatively open plots in which Lannea was not recorded, but in no case was Lannea found, either as a large or small individual, under a heavy, closed canopy. This suggests that Lannea root suckers may only develop or grow under light-exposed conditions. If this is the case, then episodes of Lannea nigritana regeneration might be expected to occur in association with canopy disturbance, a phenomenon which is patchy in both time and space.

Tree Growth Rates

In order to estimate absolute growth rates of different species of trees in Pinkwae, a comparison was made of the girth of each banded tree, at a reference point in the annual cycle, in each of the two years. The reference point which was selected for between-year girth comparisons was the first girth peak which occurred after the onset of the wet season; this peak was always followed by the rapid decline in girth which accompanied the first flush of new leaves for the year, and was therefore readily identifiable in all the species concerned. One or more higher girth peaks sometimes occurred later in the wet season (see Fig. 40); these were not used for comparative purposes, because, lacking a concomitant phenological signal, such as flushing, they were less readily distinguished from one another and between years.

Within each species, the dates corresponding to the reference girth peaks were established for 1978 and 1979, and the difference found between the girths on those two dates for each tree in the sample.

Table 18 shows the mean girth increment for the period 1978-79 in each of 12 species. In all but one of

Mean annual girth increment (cm) in 1978-79 for each of 12 tree species.

Species	Sample size	Initial girth range of sample (cm)	Mean girth increment + s.e.
<u>Ochna membranacea</u>	2	22-25	+0.188+0.093
<u>Teclea verdoorniana</u>	2	33-40	+0.005+0.675
<u>Erythroxylum emarginatum</u>	2	12-16	-0.010+0.170
<u>Millettia thonningii</u>	1	50	-0.023
<u>Lannea nigritana</u>	17	1.3-72	-0.029+0.056
<u>Drypetes parvifolia</u>	15	3-70	-0.084+0.078
<u>Antiaris africana</u>	6	25-195	-0.101+0.300
<u>Drypetes floribunda</u>	17	4-68	-0.149+0.043
<u>Diospyros abyssinica</u>	23	5-113	-0.203+0.061
<u>Dialium guineense</u>	1	42	-0.234
<u>Vepris heterophylla</u>	2	31-55	-0.385+0.455
<u>Lannea acida</u>	1	101	-0.390

the species (Ochna membranacea), the mean increment for the year was negative, indicating a net loss of girth. (In a second species, Teclea verdoorniana, there was a very slight positive mean increment, but with a very large standard error of the mean.) The mean loss of girth tended to be greatest among the emergent ^{trees} (Diospyros abyssinica, Dialium guineense, and Antiaris africana), and least - including the two with positive increments - among the understory species (Ochna membranacea, Erythroxylum emarginatum, Teclea verdoorniana). When classified in terms of habitat preference (grassland/thicket or forest), species of grassland/thicket showed the greatest loss of girth over the year. Neither of these trends is without exceptions; those which do not conform to the patterns, however, have large standard errors, suggesting that the apparent trends may be genuine but are obscured by within-species variation. Larger sample sizes would permit further elucidation of between-habitat patterns.

In those species with sufficiently large sample sizes (Antiaris africana, Diospyros abyssinica, Drypetes parvifolia, Lannea nigritana, and Drypetes floribunda), a scatter diagram was plotted of the initial girth of each tree versus its annual girth increment for the 1978-79 year. The regression of annual girth increment on initial girth was then

calculated for each species (Fig. 54), as an estimated growth curve for the year. The regression slope in each of the five species was negative, indicating that the larger individuals in each species suffered the greatest net loss of girth. A striking exception to this is seen in Lannea nigritana, however; in this species the correlation between the two variables ($r = -0.130$, 15 d.f.) was not significantly greater than zero, and the regression slope ($b = -0.002$) was insignificant as well; this means that the girth change in trees of this species was independent of the size of the tree.

A regression line for annual girth increment on initial girth was also calculated using pooled data from trees in 11 species (Lannea nigritana was omitted from the calculations). This provided an opportunity to include species having sample sizes of only one or two trees. A highly significant correlation was found when all species were pooled ($r = -0.702$, 70 d.f.; $P < 0.001$) (Fig. 55). The general pattern both within and among species, then, is for the larger individuals to have suffered a greater loss in girth over the year than the smaller individuals. The average loss differed from one species to the next, but ranged from around 0.6% to 1.1% of the initial girth.

Scatter diagrams of annual girth increment (1978-79) as a function of initial girth; scales are both in cm. (a) Aa, Antiaris africana; $y = -0.011 x + 0.740$ ($r = -0.957$, 4 d.f.; $P < 0.01$). Circled point is an apparently moribund tree; this individual omitted from the calculation of the regression line. (b) Da, Diospyros abyssinica; $y = -0.007 x + 0.088$ ($r = -0.739$, 21 d.f.; $P < 0.001$). (c) Dp, Drypetes parvifolia; $y = -0.016 x + 0.268$ ($r = -0.862$, 13 d.f.; $P < 0.001$). (d) Ln, Lannea nigritana; $y = -0.002 x - 0.025$ ($r = -0.130$, 15 d.f.; not significantly greater than zero). Circled point is an overmature tree; this individual omitted from the calculation of the regression line. (e) Df, Drypetes floribunda; $y = -0.007 x + 0.012$ ($r = -0.646$, 15 d.f.; $P < 0.01$).

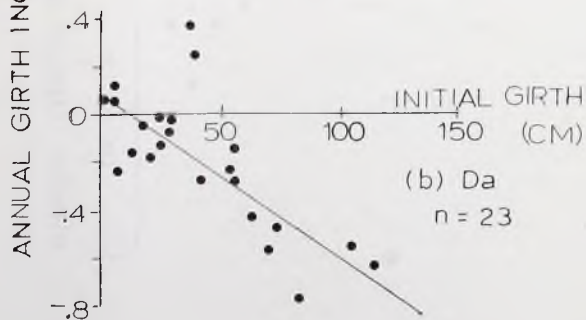
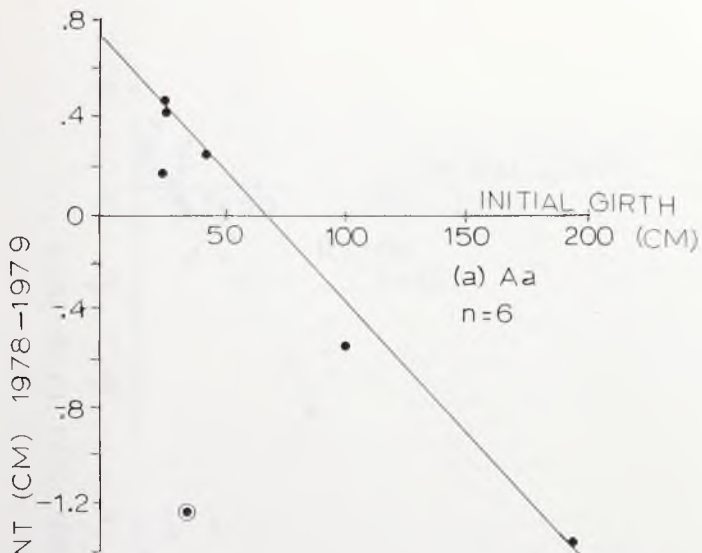

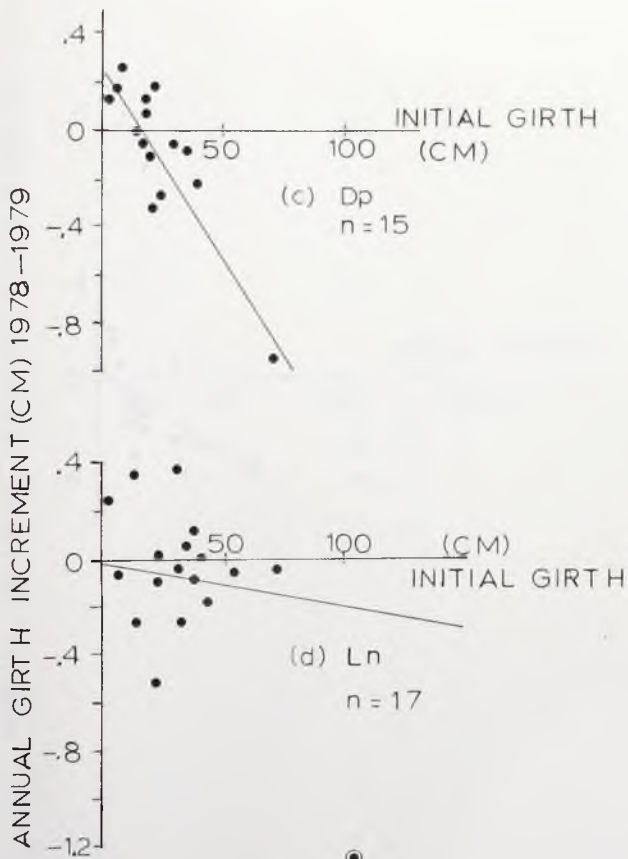

ANNUAL GIRTH INCREMENT (CM) 1978-1979

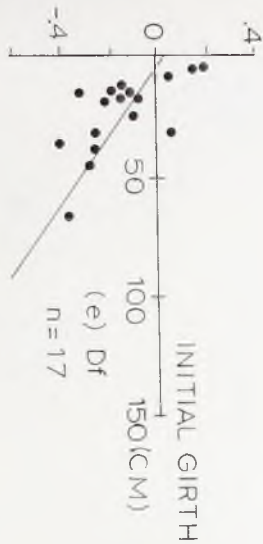
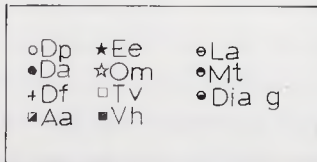
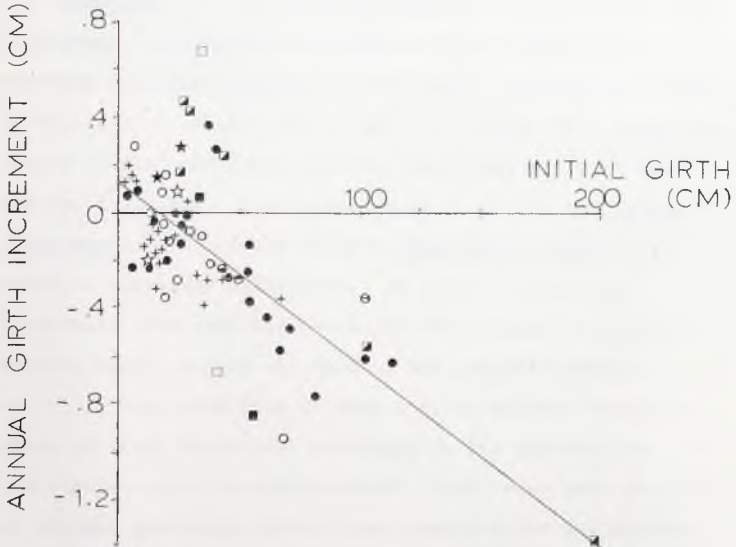

Figure 55

Scatter diagram of annual girth increment (1978-79) as a function of initial girth; scales are both in cm. Data pooled for 11 species (only Lansea nigritana was omitted); species symbols as indicated on the diagram. The correlation was highly significant ($r = -0.702$, 70 d.f.; $P < 0.001$). Regression line: $y = -0.008x + 0.123$.



Allometry

Seedlings of seven species were collected at the first-leaf stage, and measurements made of the length of the root and the above-ground shoot of each. Drawings were made of the species as well (Fig. 56). Table 19 shows the length of root and shoot and the root/shoot ratio of each species collected. The ratios range from 0.68 in Dialium guineense to 3.28 in the climber Calycobolus heudelotii, nearly a five-fold difference. In order to test the hypothesis that seedling mortality rates might be related to rooting depth, a plot was made of the percent mortality of 2.5 cm high seedlings of each species against the root/shoot ratio of first-leaf seedlings of the species; no correlation could be demonstrated. Plots were made as well of percent mortality against root length alone and against total seedling length (root plus shoot); in no case was a significant correlation found. It is thus likely that differences in rooting depth are not the principal determinants of differential mortality among seedling species. It is still entirely possible that differences in rooting depth among seedlings of the same species may occur and may contribute to differential mortality within the species; this was not tested, however, because of insufficient data.

Drawings of seven seedling species showing relative lengths of root and shoot. Seedlings were collected at the first-leaf stage. (a) Dialium guineense; (b) *Canthium horizontale; (c) Erythroxylum emarginatum; (d) Drypetes parvifolia; (e) Teclea verdoorniana; (f) Drypetes floribunda; (g) *Calycobolus heudelotii. Species with an asterisk are climbers; all others are trees. Horizontal line indicates ground level.



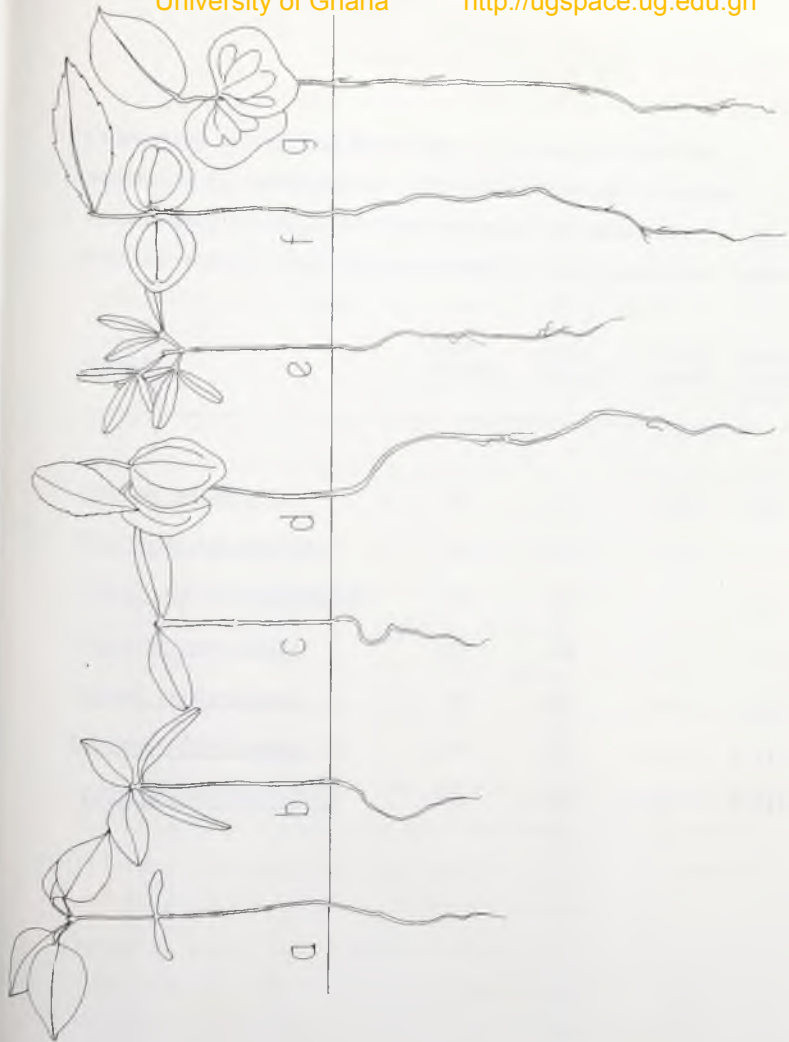

Table 19

Comparison of rooting depth and root/shoot ratios for seedlings of seven species (first-leaf stage). Lengths are in mm. Drawings of these species are shown in Fig. 56. Species with an asterisk are climbers; all others are trees.

Species	Root length	Shoot length	Total length	Root/shoot ratio
<u>Dialium guineense</u>	42	62	104	0.677
* <u>Canthium horizontale</u>	33	46	79	0.717
<u>Erythroxylum emarginatum</u>	33	40	73	0.852
<u>Drypetes parvifolia</u>	105	68	173	1.544
<u>Teclea verdoorniana</u>	68	40	108	1.700
<u>Drypetes floribunda</u>	109	57	166	1.912
* <u>Calycobolus heudelotii</u>	105	32	137	3.281

The relationship between trunk and crown growth was examined in five species of trees. For each species, a regression was plotted of the trunk diameter at breast height versus the mean crown diameter (based on two perpendicular diameter measurements) of a sample of trees. Trees were selected only to include a wide range of trunk sizes.

Figure 57 a-e shows the regression plots. The highest regression slopes were found in the two emergent marginal species (Antiaris africana, 0.181; Lannea nigritana, 0.250). Lower, nearly identical, slopes were found in the two non-marginal canopy species (Diospyros abyssinica, 0.171; Drypetes floribunda, 0.172). The lowest slope (0.164) was found in Drypetes parvifolia, a species of the lower canopy. Although the correlation is quite high in all the species, it is again highest in the emergents, and lowest in Drypetes parvifolia.

It is probable that the general allometric relationships within species are genetically determined, and that the observed differences between species can best be explained in those terms. However, it is also probable that the observed trends are related, at least in part, to the fact that trees growing in open situations are less likely to experience suppression by larger trees than are those which

Figure 57

Regression of mean crown diameter (m) against trunk diameter at breast height (cm) for five tree species. (a) Antiaris africana, a tall emergent species of thicket clumps and forest margin; $y = 0.181x + 1.594$; $r = 0.951$, 8 d.f.; $P < 0.001$. (b) Lannea nigritana, an emergent pioneer species of forest margins and gaps, $y = 0.250x + 0.855$; $r = 0.881$, 10 d.f.; $P < 0.001$. (c) Diospyros abyssinica, an emergent tree of closed-canopy forest; $y = 0.171x + 0.655$; $r = 0.926$, 11 d.f.; $P < 0.001$. (d) Drypetes floribunda, a canopy tree; $y = 0.172x + 1.204$; $r = 0.856$, 9 d.f.; $P < 0.001$. (e) Drypetes parvifolia, a small canopy tree; $y = 0.164x + 1.023$; $r = 0.805$, 13 d.f.; $P < 0.001$. Note that the slopes tend to be highest in the emergent margin species and lowest in the canopy species.

CROWN DIAMETER (M)

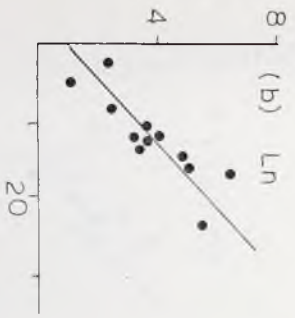
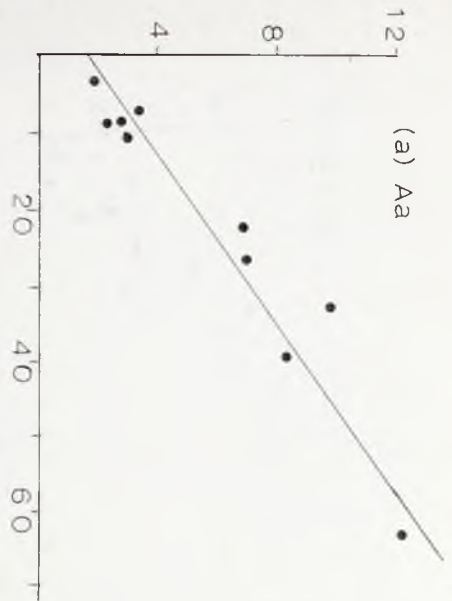

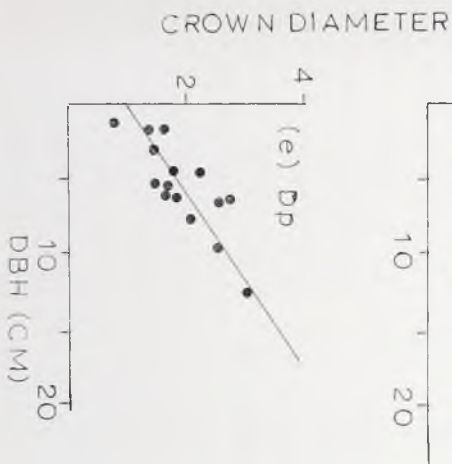

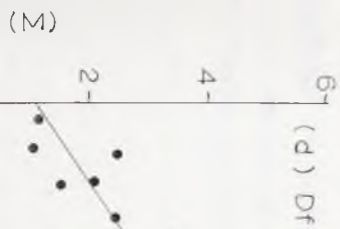

grow up under a closed canopy. This would account for both the lower slope and greater scatter of points in Drypetes parvifolia, for example; this is a species which has a rather narrow crown even in the largest individuals, and which may face suppression throughout its development.

STRUCTURE AND DYNAMICS

Introduction

Plant succession was originally perceived as a deterministic process whereby a community returns to a predictable stable state (defined by species composition, diversity, structural complexity, and productivity) following perturbation (Clements 1916). Succession was thus seen to be an emergent property of the community (Horn 1976).

More recently, it has been recognized that succession shows a variety of patterns, only one of which conforms to the model of Clements (Horn 1976). In order to cope with the diversity of patterns encountered, recent thought has encompassed the notion that succession is the outcome of a stochastic process of tree-by-tree replacement (Drury and Nisbet 1971, Connell 1972, Horn 1975). This has permitted the modelling, within a unified conceptual framework, of the full range of succession patterns found in natural communities (Horn 1976). The models are generally of

the following form: a transition matrix is constructed to define the probability of any tree being replaced by a member of the same or of another species in a given period of time; the probabilities themselves are taken to be constant with time, and are a function of the biological interactions between and within the various species. This transition matrix is multiplied repeatedly by a vector of species abundances, until a stable configuration is attained. A succession thus defined is not deterministic - the stable outcome need not be unique. The steady state may be reached rapidly or slowly, depending upon the kinds of interactions which obtain.

The four major categories of succession described by Horn (1976) are (1) chronic, patchy disturbance, in which frequent, localized disturbances set the stage for stochastic replacement of species with a minimum of competitive interactions; succession in this case is rapid, convergent, and not strongly biased by historical accident; (2) obligatory succession, in which early species "prepare" the habitat for subsequent species; in this model, which conforms to Clement's perceptions, convergence is certain but slow; (3) competitive

hierarchy, a complex situation in which late arrivals are increasingly able to dominate, but are also capable of themselves invading new patches; this mode, which may reflect historical accidents, appears to be an important feature of north temperate forest successions (Heinselman 1973); and ⁽⁴⁾ "quasi-reality", in which all four patterns play a role; this has been shown to be highly predictive of natural events in a New Jersey forest dominated by four species.

Tropical forests have been found to show a number of these patterns, or at least facets of them. Patchy disturbance, followed by the invasion of any of several species may dominate the successional pattern (Richards 1952, Webb et al. 1972, Longman and Jeník 1974, Knight 1975) and contribute to local species diversity (Strong 1977, Connell 1978). Where gaps are large, obligatory succession is clearly important: shade-tolerant primary forest species do not generally appear in gap areas until a substantial canopy has been formed by the invading pioneer trees (Richards 1952, Swaine and Hall, unpublished). Some mature forest species in Panama do, however, also invade recently abandoned fields (Knight 1975), which would suggest that a competitive hierarchy could occur.

It is likely that "quasi-reality" - the combination of several basic patterns - will be found most successful in describing tropical forest succession, as it has in temperate forests.

There is no doubt that disturbance patterns - magnitude, spatial distribution and frequency of occurrence - are important factors in the outcome of a successional sequence. Disturbance may upset the relative frequencies of species in a community, thereby retarding or hastening convergence on a stable state, or may affect the ultimate stable state which occurs (Horn 1976). Disturbance has been shown to bring about alterations in diversity, by a number of mechanisms; diversity is lowered when disturbance is severe enough to completely eliminate species or to prevent their establishment in the first place (Harper 1969), and under such circumstances, particularly resistant species may become dominant (Lock 1972). Diversity tends to be increased when disturbances non-selectively reduce biomass, or when disturbance is less harsh (Harper 1969, Lieberman et al. 1979), as the competitive interactions between plants are interrupted or prevented. Patchy disturbance may also increase diversity by introducing new microhabitats (Strong 1977).

Disturbance in tropical forest involves natural tree falls, felling of trees by man, farming, landslides, and fires (Richards 1952, Daubenmire 1968, Hartshorn 1978), although the relative importance of different types of disturbance varies from one forest to the next. Natural tree falls may open small or large gaps, depending upon the height of the trees, the extent to which adjacent crowns are interwoven by climbers, and whether the tree crashes to the ground or "dies on its feet". It is the impression of several authors that tropical forest trees often die standing, gradually shedding branches, bark, and pieces of the bole itself (Whitmore 1978, and discussion following that paper). Windthrows of diseased or healthy trees do occur, however, particularly in top-heavy individuals whose crowns protrude above the level of the canopy; Whitmore (1968) points out that, however rarely they occur, windthrows are, by virtue of their catastrophic nature, extremely important in tropical forest dynamics.

Cutting of trees by man, whether for timber extraction or farming, is unquestionably the most significant source of disturbance at present in tropical forest (Prance 1977). Only those forests which are lacking in marketable timber species and are on soils too poor for

farming are free of this kind of disturbance. The pattern of cutting greatly influences the nature of the succession which follows. Hartshorn (1978) has commented that high-grading, or the selective removal of valuable timber species, leaves sparse scars in the vegetation which are rapidly grown over with secondary species; natural tree falls in such areas are, for a time, rarer than is found in virgin forest, and the production of middle-sized and large gaps is thus retarded. Clear-felling of large areas of tropical forest, is, obviously, extremely destructive, and the reversion of such areas to mature forest may be slow or may not occur at all; problems of re-seeding, soil erosion, and physical and chemical changes in exposed soils may contribute to the arrested regeneration of such areas. It is widely felt that virtually all extant tropical forest has been disturbed at some time by man.

Fire may or may not be important in dry forest, depending upon the mass and flammability of the undergrowth and the nature of the surrounding vegetation; Hall and Swaine (1976) found that ground-fires sweep through the undergrowth of savanna-bordered forest about every 10 years, killing the young trees and leaving the old. This kind of periodic disturbance, in which only small individuals are

removed, might tend to favour the establishment of an even-aged, low-diversity regeneration cohort, after each fire, the cohort being dominated by whatever species chanced to seed heavily in that year. Fires in wet tropical forests are generally highly localized and rare (Richards 1952), and depend upon peculiarities of weather.

Although disturbance and its *aftermath* presents a dramatic *focus* around which to consider tropical forest dynamics, it has been long recognized that even undisturbed, mature tropical forest is not static. Aubréville (1938) was impressed by the general observation that some canopy species appear not to regenerate. His classic mosaic theory of regeneration seeks to resolve this paradox by invoking a spatially dynamic equilibrium: if regeneration is highly patchy, then the young trees in the understorey, in a given part of the forest, may be of different species than those which they will ultimately displace in the canopy; further, the offspring of the canopy species may themselves be in the process of displacing another group of canopy trees elsewhere in the forest; and so on. Aubréville did not attempt to explain why regeneration would assume this peculiar patchy configuration, although more recent authors have suggested

that heavy seed or seedling mortality in the vicinity of parent plants would tend to produce spatial separation between parents and offspring (Janzen 1970, Connell 1971); this mortality is seen to be the outcome of patchy herbivore pressure by specialist herbivores which congregate around parent plants. While seed and seedling predation are clearly significant causes of mortality in at least some tropical forests (Smythe 1970, Connell 1971, Janzen 1969, 1978), the alternative possibility is as yet untested that patchy regeneration and the spatial segregation of parents and offspring in high diversity forest would result, without the intervention of herbivores, from sporadic reproduction and fortuitous events leading to the successful establishment of offspring in some areas and not others. Sporadic reproduction is characteristic of a number of mature tropical forest trees (Janzen 1978).

Tropical forests have been said to be "more dynamic" than temperate forests, based upon the casual observation that falling trees and branches are constantly heard in tropical forest (Jenik, in discussion following Hartshorn 1978). The turnover rate of a forest in Costa

Rica has recently been calculated, if only roughly, as 118 ± 27 years; this estimate was based upon the area and rate of gap formation in a study plot of 1.2 ha during a period of 6 years. Faster turnover rates were recorded in swampy terrain, which is not surprising given the instability of the soil. Gap formation was most pronounced in very stormy periods; this, along with the fast rates of growth in wet forest trees, has led to the prediction that humid tropical forests should be more dynamic than dry forests (Hartshorn 1978). The assumption is implicit in the calculation of turnover rates as carried out by Hartshorn (1978) that the forest is in a state of equilibrium: gaps are forming and filling at comparable rates. In the forest concerned, which is mature and undisturbed, this is probably a reasonable assumption. In much of the tropics, however, human influence has driven the rate of gap formation far higher than its natural level. Tropical forest is being removed, world-wide, at the alarming rate of 11 million ha per year (more than 20 ha per minute), according to one recent report (Prance 1977). It remains to be seen whether, and under what circumstances, the natural restoration rate is adequate to bring about the reversion to mature tropical forest of this rapidly increasing gap area.

Methods

The structure, physiognomy, and floristics of the forest and thicket areas were assessed and compared; the field procedures used are, for the most part, described under Methods in preceding sections.

A transect 5 m in width was laid out across the centre of Pinkwae, from the northern margin to the southern margin. The location of the transect is indicated in Fig. 5b. All trees on this transect of 20 cm girth or more were girthed, identified, and mapped to the nearest 1 m.

Mapping was also done within a 60 m x 60 m (0.36 ha) plot near a gap in the forest (see Fig. 5b). In this plot, all trees over 3 m in height were girthed, identified, and mapped, and this information was used in a study of species dispersion patterns.

A number of approaches have been used in the past in the study of successional trends or patterns in vegetation. The most direct, and hence most effective, technique is the repeated sampling of vegetation through time (Daubenmire 1968, Williams et al. 1969). This is especially suitable when succession

is very rapid, but may also be feasible when rates are slower; permanently marked (or otherwise identifiable) plots may be re-assessed over a period of months, years, or decades. Photographic records are useful in this regard, particularly when changes in cover, rather than species composition or diversity, are of interest.

When direct observation is impossible, either because of exceedingly slow rates of succession or the impossibility of re-visiting the site after an appropriate lapse of time, inferences can be drawn by indirect means concerning the dynamics of the vegetation. Such inferences are most often based wholly on the standing vegetation at the time of sampling, but may be supplemented by ancillary information. If the age (or length of time since disturbance) is known for various stands within a habitat, they may be compared with one another under the assumption that they represent a time series (Knight 1975). Comparative approaches of this kind may or may not utilise data on the population structure of the species present (Knight 1975, Lawton 1978).

Ordination has proved to be a valuable tool in studies of vegetation dynamics. Many recent studies have used this method, including those based upon direct observation of the vegetation through time (Swaine and Greig-Smith 1979) as well as those relying on indirect inferences (Goff 1968, Carleton and Maycock 1978, Lawton 1978). Most such studies have sought to resolve the floristic relationships between stands of different ages, or the successional position, through time, of various species. Several recent studies have followed or modified, the innovation of Goff and Zedler (1972), who represented species not as points, but as vectors in ordination space; distance along the vector represents increasing tree age (inferred from girth).

The approach adopted in this study has, necessarily, been an indirect one. A number of plots 0.01 ha in area were enumerated throughout Pinkwae (details of the procedure are given under Methods in the preceding section). The species recorded in each plot were separated into two groups, trees over 3 m in height on the one hand, and seedlings and saplings (all plants 3 m in height or less) on the other. Each plot thus had two independent species lists. These were ordinated (using reciprocal averaging) in order to

explore the floristic relationships between the mature, canopy population at each site and the population of young plants which would, in time, replace it.

In order to assess the dynamic relationships, if such exist, between forest and other kinds of woody vegetation on the Accra Plains, an ordination was carried out using all the Pinkwae plots (including trees and saplings, pooled - that is, all plants of 1 m in height or more); a number of sample plots from large patches of degraded thicket; and enumeration data from several small thicket clumps of the typical Capparion form.

Aerial photographs of the study area taken in 1961 were obtained from the Ghana Survey Department. These provided a useful adjunct to the floristic studies of vegetation dynamics, and permitted an evaluation of the rate at which the cover of woody vegetation has changed since that time.

Results

Transect

A NW-SE transect was surveyed across Pinkwae, and all trees of 20 cm girth or more were girthed, identified, and mapped. A total of 226 trees belonging to 14 species were mapped.

The density of trees along the transect is shown in Fig. 5a. The density is clearly variable, but does not appear to be strongly related to position on the transect. Density is, on the whole, higher on the leeward (northern) side of the summit. Large gaps were found around 60 m and 300 m from the north-west margin and smaller gaps were found at 120 m and 450 m. The gap at 120 m was filled with small saplings, predominantly of Drypetes parvifolia, which were heavily laden with small stems of the thorny climber Capparis erythrocarpos. The larger gaps were filled with a low mass of old, heavy climbers, mainly Capparis erythrocarpos, Grewia carpinifolia, and Uvaria ovata; these gaps had few saplings within them, although large trees of Lannea nigritana and Dialium guineense were present around the gap margins.

The largest tree in each 20 m x 5 m section along the transect is plotted in Fig. 5b. Again, the maximum girth

Figure 58

Girth of the largest tree in each of 28 sequential 20 m x 5 m plots along a northwest-southeast transect through Pinkwae.

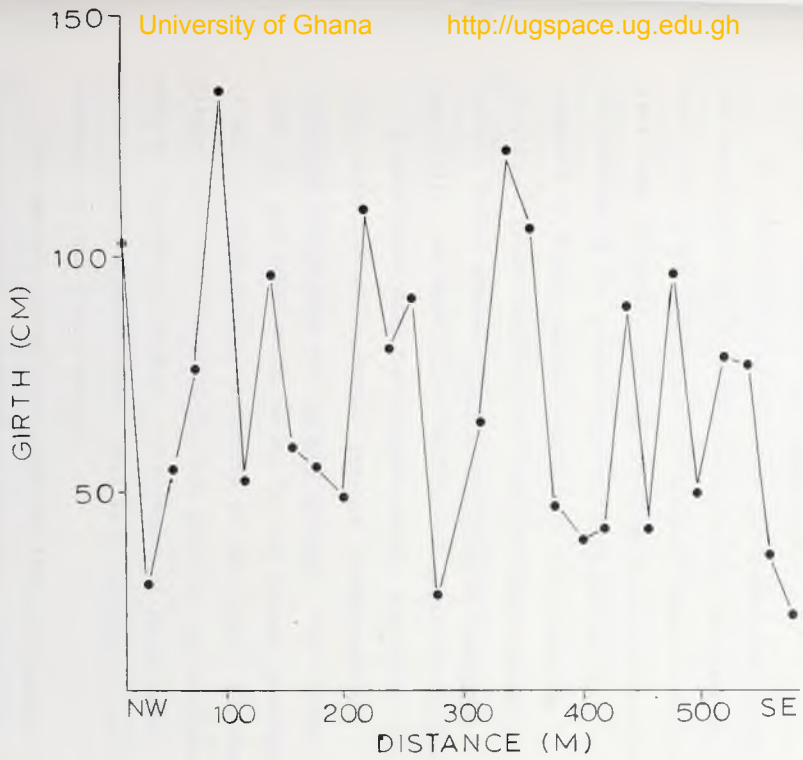

1486

shows an irregular pattern, and gaps are apparent. Large trees are not absent from the northern marginal areas, suggesting that the margin, at least in the transect area, is not in a process of rapid expansion.

The tree density and maximum girth were both lowest at the south-east margin. This is an area of low (3-4 m), thin canopy; the undergrowth is somewhat heavier in this area than elsewhere, although seedling density is not high. The outline of the forest edge in the region of the transect is fairly uneven, and dotted with broken-up islands of forest and thicket; some of these islands contain forest species (Vepris heterophylla, Drypetes parvifolia, and others), as well as the usual thicket trees. The ground cover near that margin outside the forest is a dense cover of tall perennial grasses, predominantly Vetiveria fulvibarbis and Panicum maximum. This becomes quite dry and inflammable during the dry season, although it was not burnt during the period of the study. It seems likely that fires occasionally burn parts of the southern edge of the forest; however, no evidence of recent past fires (such as charred stems) were seen anywhere within the forest or at the forest margin.

The species composition along the transect appears to be quite patchy. Clumping of species is especially

noticeable in Afraegle paniculata and Willetia thonningii, both of which are rare, emergent trees in Pinkwae; in addition to the mature trees, seedlings of these species are very scarce, and no saplings at all were encountered in the study. Teclea verdoorniana is another rare species which was clumped on the transect; this species, which does not exceed a height of 5-6 m, does produce relatively abundant seedlings. Lannea nigritana was abundant and somewhat patchy in its distribution on the transect.

Drypetes parvifolia, Drypetes floribunda, and Diospyros abyssinica were abundant and distributed throughout the transect. No species were confined to the marginal areas on the transect.

Basal Area

Basal area ($m^2 ha^{-1}$) was determined for trees, saplings, and climbers in each of the enumerated 0.01 ha plots. Basal area values were calculated from measurements of girth at breast height. Plots were grouped into marginal (southern or northern) and forest (non-marginal) plots, and the basal areas of trees, saplings, and climbers in each group calculated. Total basal area is highest in forest plots, and lowest in plots on the northern margin of the forest (Table 20). Southern marginal plots are intermediate in basal area. Tree basal area contributed most heavily to the observed differences in total plot basal area. Climber basal area comprised, on the average, 4.4% of the total forest basal area; 1.6% of the southern marginal basal area; and 2.9% of the northern marginal basal area. Mean sapling basal area did not differ significantly between groups.

If the progression of seedlings into the sapling stage is suppressed by the presence of large trees in the plot (by pre-emption of light or other resources), then the number of saplings should be inversely related to tree basal area in the plot. A regression was calculated for the forest plots (omitting marginal plots) of sapling density on tree basal area (Fig. 59); there is a significant

Basal area ($\text{m}^2 \text{ ha}^{-1}$) of trees, saplings and climbers in 0.01 ha plots in Pinkwae. Plots divided into marginal and non-marginal groups. Number of plots in each group given in parentheses. Basal area given as mean \pm standard error of the mean.

Basal area	Forest plots (28)	Southern marginal plots (4)	Northern marginal plots (5)
Trees	25.8 \pm 1.61	20.7 \pm 2.17	14.9 \pm 1.89
Saplings	0.08 \pm 0.014	0.09 \pm 0.019	0.06 \pm 0.008
Climbers	1.19 \pm 0.191	0.33 \pm 0.059	0.45 \pm 0.084
Total	27.08 \pm 1.627	21.11 \pm 2.170	15.46 \pm 1.956

15/4

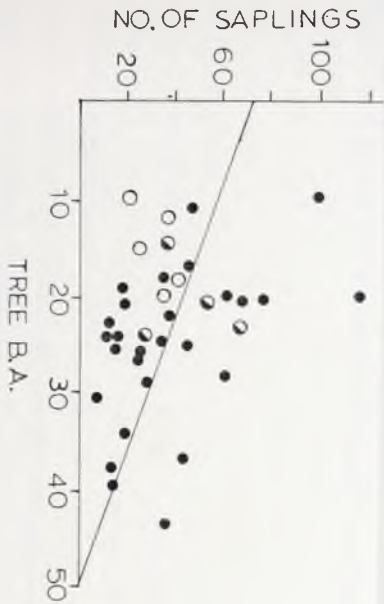

1407

1516

negative correlation between the two ($r = -0.438$, 25 d.f.; $P < 0.05$). Northern marginal plots show the greatest departure from the regression line, having consistently lower tree basal area and sapling density than other plots. This would indicate that they are, compared with forest plots, under-stocked, and that sapling density is not primarily a function of stocking in the adult tree classes.

Species Dispersion Patterns

Early writings on tropical forest propounded the notion that tropical forest tree species tend toward low density and uniform dispersion, and some field studies have supported this view (Black et al. 1950). It is now accepted as a general truth by most current textbooks in ecology (MacArthur 1972, Emlen 1973, Pianka 1978, and others). The generality of the observation may, however, be questionable. Contagious (clumped) dispersion of individuals has been found in many species of southeast Asian rainforests (Poore 1968, Ashton 1969), and uniform dispersion patterns seem to be rare (Greig-Smith 1969). Clumped dispersion in these forests appears to result largely from inefficient seed dispersal (with seeds falling directly under the parent). Striking evidence of clumping among members of nearly all species in a dry tropical forest in Costa Rica has been presented recently (Hubbell 1979). In this forest the clumping is considered to result in part from limited distances of seed dispersal by mammals, and also as the expected outcome in a forest comprising many small gaps of different ages in which regeneration is occurring.

In order to evaluate the dispersion pattern of species in Pinkwae, an area of 60 m x 60 m (0.36 ha) was mapped.

The plot was chosen to include part of a large gap as well as typical closed-canopy forest, so that microhabitat differences among species could be examined. All trees of 3 m height or greater were identified, girthed, and mapped to the nearest 1 m. As described earlier, stems separated at ground level by 3-4 cm or more were treated as separate individuals.

The map included 748 trees belonging to 15 species. The map positions of individuals of each species are shown in Fig. 60 a-e.

The density of trees was calculated on the basis of 0.28 ha, subtracting the area of the middle of the gap from the total, as this part of the plot was devoid of trees. The total density of trees of 3 m height or greater was 2,671.4 trees ha⁻¹. Densities of individual species ranged from 1,510.7 trees ha⁻¹ (*Drypetes parvifolia*) to 7.1 trees ha⁻¹ (*Malacantha alnifolia*).

Distances from each tree to its nearest conspecific neighbour were measured on the map. Trees which were nearer to the edge of the plot than to a conspecific were not considered. The frequency distribution of nearest neighbour distances was plotted for each of the eight most common species in the mapped area (Fig. 61 a-h).

Figure 60

Map of trees on 0.36 ha sample plot in Pinkwae; all trees 3 m in height or greater included. Tm, termite mound; foot path indicated by broken lines.

(a) Dp, Drypetes parvifolia; Bn, Baphia nitida; Ma, Malacantha alnifolia. (b) Df, Drypetes floribunda; Om, Ochna membranacea; Mt, Millettia thonningii. (c) Ln, Lanea nigritana; Cc, Cassipourea congoensis; Ff, Flacourtia flavescens. (d) Da, Diospyros abyssinica; Ee, Erythroxylum emarginatum; Dic g, Dichapetalum guineense. (e) Dia g, Dialium guineense; Ca, Chaetacme aristata; Vh, Vepris heterophylla.



● ● ● Dp
★ ★ ★ Bn
▲ ▲ ▲ Ma



(e)



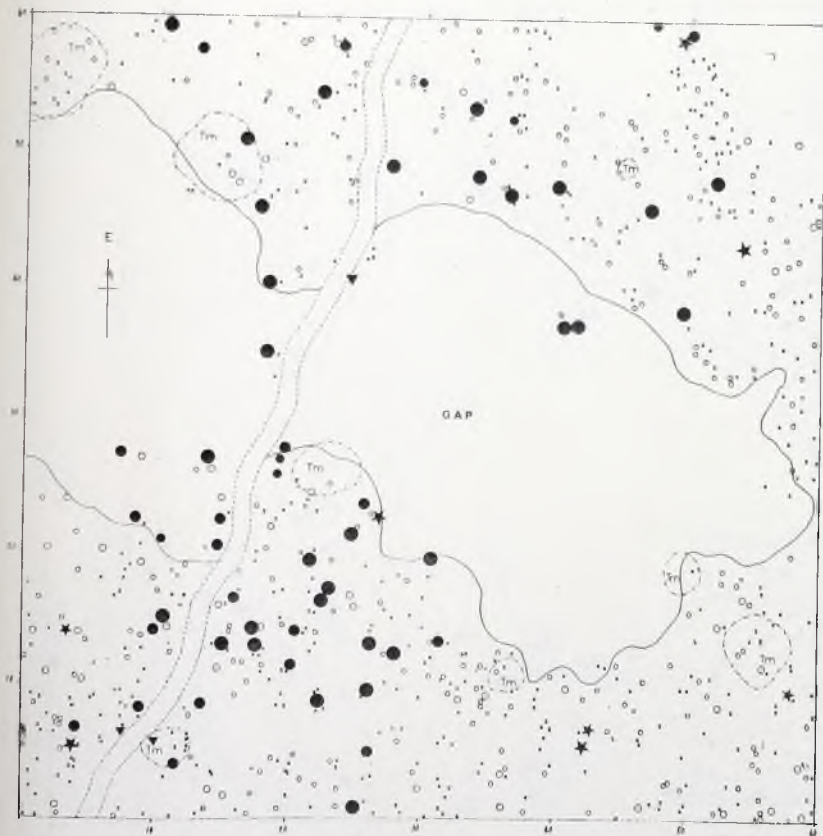

- Ln
- ★★ Cc
- ▼▼ Ff





- ● ● Dia g
- ★ ★ Ca
- ▼ Vh

Figure 61

Frequency distribution of nearest neighbour distances for eight tree species. Distances (m) are to the nearest conspecific tree 3 m or more in height.

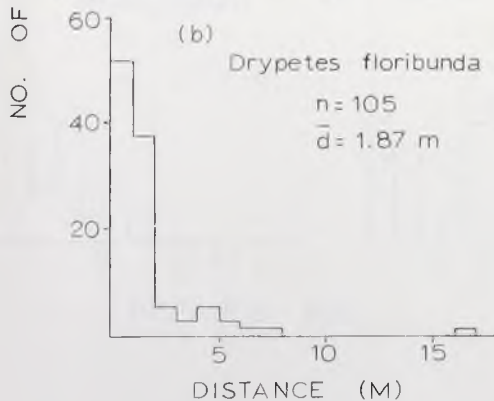
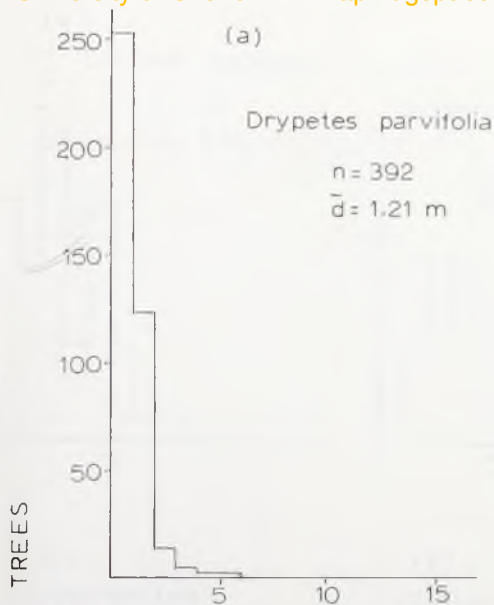

(c)

Lannea nigritana $n = 52$ $\bar{d} = 3.16 \text{ m}$

NO. OF TREES

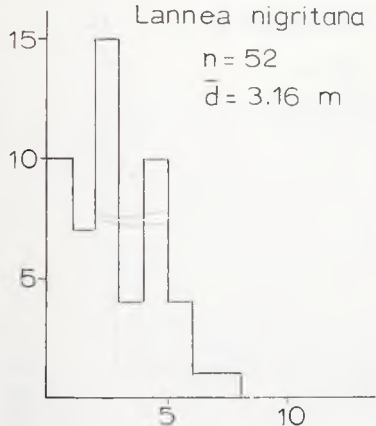

(d)

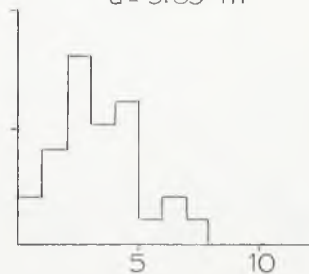
Diospyros abyssinica $n = 29$ $\bar{d} = 3.59 \text{ m}$ 

(e)

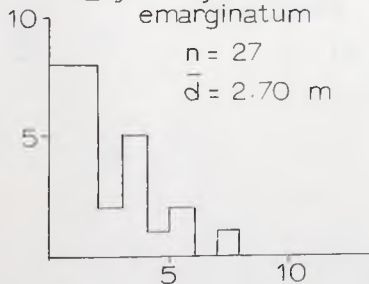
Erythroxylum emarginatum $n = 27$ $\bar{d} = 2.70 \text{ m}$ 

(f)

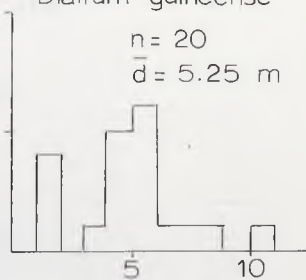
Dialium guineense $n = 20$ $\bar{d} = 5.25 \text{ m}$ 

DISTANCE (M)

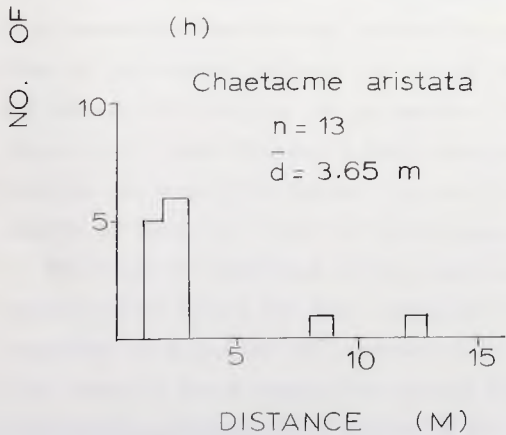
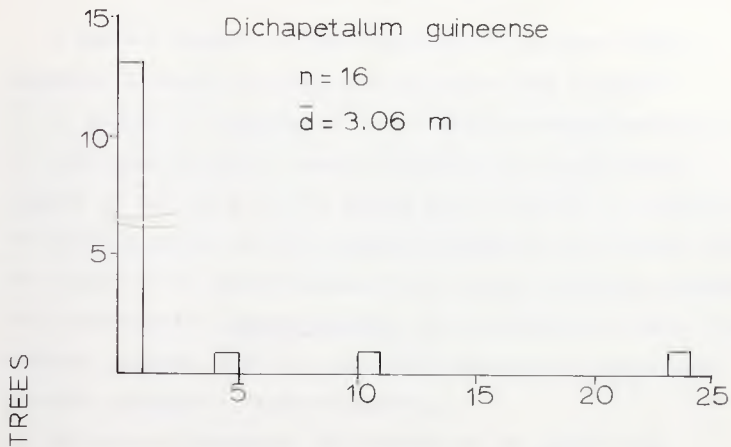

A scatter diagram of the logarithm of the mean nearest neighbour distance for each species versus the logarithm of the number of individuals in the species demonstrates that at least nine of the 14 species plotted are significantly clumped at the scale of the sample plot (Fig. 62). Four of the species appear to have randomly dispersed individuals, and the trees of one species appear to be rather uniformly dispersed. This last species (Baphia nitida) was represented by only five members, however, and it is possible that over a larger area it would approach a random dispersion.

In order to determine the effects of the gap on the distribution of species, trees were enumerated in the following four subsamples from the map: within the gap; between 0-5 m from the gap margin; between 5-10 m from the gap margin; and between 10-15 m from the gap margin. The species diversity of trees (Shannon's index) decreases monotonically from the gap toward the forest (Fig. 63), although the density of trees is lowest within the gap.

The relative importance of the eight most common tree species varied within the four subsamples (Fig. 64). Importance of a species was measured as the percentage of total trees in the subsample contributed by the given species. Dichapetalum guineense was confined to the gap and the area within 5 m of the gap, although it was absent from the centre

Figure 62

Plot showing degree of clumping in 14 tree species, as measured by mean nearest neighbour distance (m). Diagonal line is the expected nearest neighbour distance for randomly dispersed populations; the expected distance \underline{d} is defined as $\underline{d} = 1/(2\sqrt{\rho})$, where ρ is the mean density in number of trees per square meter (Clark and Evans 1954).

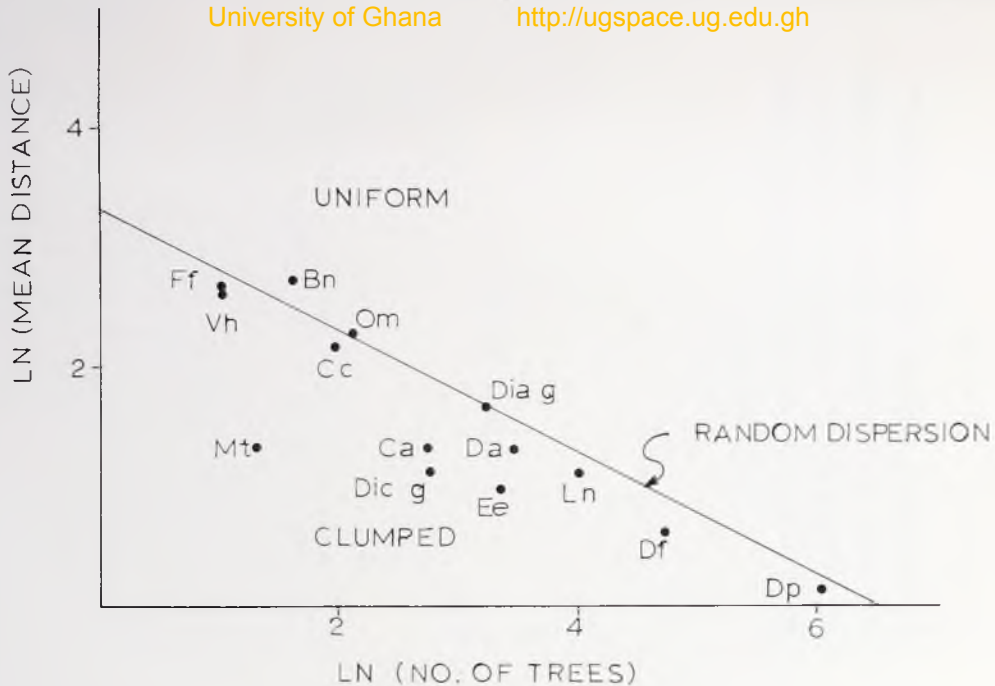

Figure 63

Diversity of trees (Shannon's index H'), and number of trees sampled, for four adjacent samples: within a large gap; 0-5 m from gap; 5-10 m from gap; and 10-15 m from gap. Solid line, diversity; dashed line, number of trees.

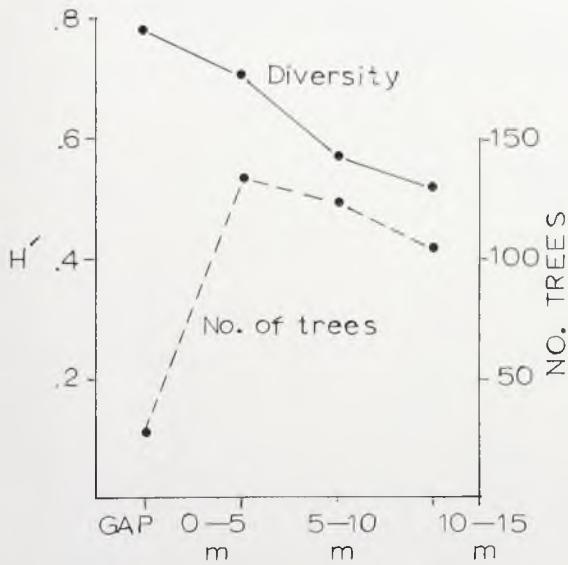
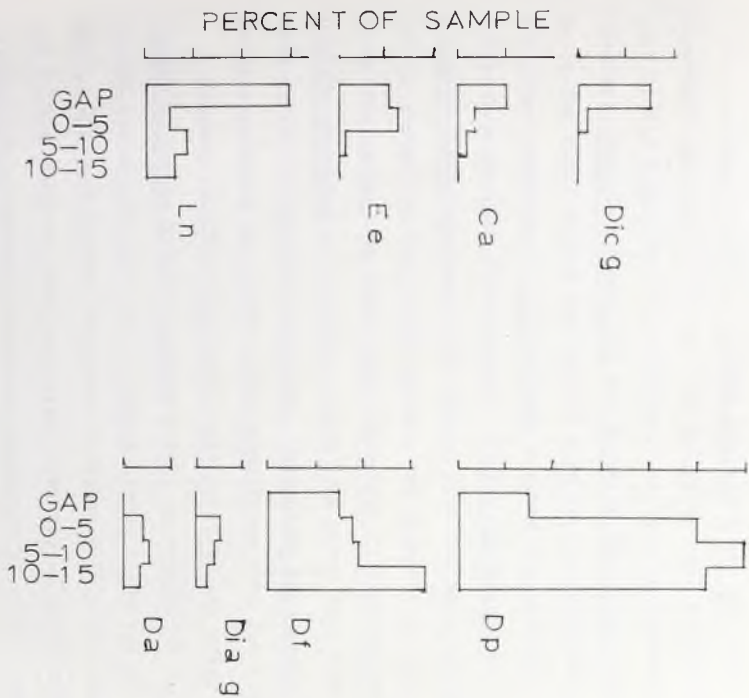

Figure 64

Relative importance of eight tree species in four adjacent samples: within a large gap; 0-5 m from gap; 5-10 m from gap; and 10-15 m from gap. Divisions on vertical scale at intervals of 10 per cent.



155 f

of the gap. Chaetacme aristata and Erythroxylum emarginatum were predominantly found in the gap and within five metres of the gap, although they occurred in low numbers in the 5-10 m subsample as well. Lannea nigritana was the most important species in the gap, and did occur well within the gap; it was found with some abundance in all the subsamples however. Drypetes parvifolia and Drypetes floribunda both had a few trees within the gap but were best represented in the other subsamples; D. floribunda reached its greatest importance farthest from the gap. Dialium guineense and Diospyros abyssinica were both absent from the gap, although in the former species, which was not too abundant in the plot, the absence may have been influenced by sampling error; Dialium guineense is a species which does occur from time to time in fairly exposed conditions. Diospyros abyssinica may be more confined to closed-canopy conditions than the other species.

Nearest neighbour distances were measured for trees of Lannea nigritana within a Lannea patch. A subplot of 0.0675 ha within the mapped plot had 33 Lannea trees, a density of 489 trees ha^{-1} . The mean nearest neighbour distance within the subplot was 2.67 ± 0.260 m; this is greater than the expected mean distance in a randomly dispersed population (2.26 m), indicating that Lannea trees are hyper-dispersed within patches.

Physical Structure

A comparison was made of the life form spectra of forest and thicket in the Pinkwae area. Species of vascular plants (see Appendix) were placed in the following groups: climbers (lianes); mesophanerophytes (large trees 8-30 m in height); microphanerophytes (small trees 2-8 m); nanophanerophytes (dwarf trees or shrubs 0.25-2 m); chamaephytes (herbs and shrubs less than 0.25 m); geophytes; and parasites. (The classification follows that of Raunkiaer (1934)). A total of 94 species were thus classified. Species were then grouped into those occurring in forest only, in thicket only, or in both habitats, and life form frequencies were tabulated for each habitat (Table 21). Under "forest" in the table are listed species found in forest only together with species found in both habitats; and under "thicket" are listed thicket species as well as those found in both habitats.

The life form distribution in the two habitats is remarkably similar. In both habitats, climbers contribute the largest number of species, followed by small trees, large trees, and shrubs (or dwarf trees), in that order. Chamaephytes, geophytes, and parasites

Frequency of life forms in forest and thicket near Pinkwae.

	Habitat		No. species (total)	Similarity (%)
	Forest	Thicket		
Life form				
Climbers	30	22	34	53
Mesophanerophytes	7	9	13	23
Microphanerophytes	16	16	25	28
Nanophanerophytes	4	10	13	8
Chamaephytes	5	4	6	50
Geophytes	1	2	2	n.a. ^a
Parasites	0	1	1	n.a. ^a
TOTAL	63	64	94	30
Life form diversity				
(H')	1.387	1.626	(t = 1.858, 122 d.f.; n.s.)	

^aNot calculated due to small number of species.

contribute few species to either habitat; vascular epiphytes are completely lacking, as are stranglers and megaphanerophytes (giant trees over 30 m in height).

Climbers comprise a greater proportion of species in forest (48% of total) than in thicket (34%), and shrubs comprise a smaller proportion in forest (6%) than in thicket (16%), but these differences are not statistically significant ($P > 0.05$).

An index of life form diversity (Shannon's index H') was calculated for each habitat (Table 21); the life form diversity was slightly, but not significantly higher in thicket than in forest ($t = 1.858$, 122 d.f.; $0.05 < P < 0.1$).

The floristic similarity of the forest and thicket was compared using Jaccard's index of similarity (species common to both habitats \times 100/total number of species). The similarity between the habitats, based on all species, was 30% (Table 21). Within individual life form groups, however, the between-habitat similarity values ranged from a high of 53% in climbers to a low of 8% in shrubs. Between-habitat similarity values in other groups were 50% (chamaephytes), 28% (small trees), and 23% (large trees). Values were not calculated for geophytes or parasites because of the small number of species in those groups.

As indicated by their surprisingly similar life form distribution and life form diversity, the forest and thicket habitats are of comparable structural complexity. The species composition of the two habitats is relatively distinct, however, and for this reason one cannot interpret the structural similarity as merely the consequence of floristic similarity. Richards (1952) commented upon the great similarity in life form distributions in climax rain forests which have profound floristic differences, and in a later paper (1969) mentions the importance of the number of synusiae (or life forms) present in determining the overall species diversity in plant communities. This echoes the original observation of Raunkiaer (1934) that areas with similar climates have life form spectra that are correspondingly similar (Daubenmire 1968). The absence of several life forms from Pinkwae which are important components of wetter forest contributes to (but does not entirely explain) the much lower species diversity found in Pinkwae.

Physiognomic differences between forest and thicket are obvious, and are the principal basis for distinguishing the two vegetation types: thicket is dense, impenetrable, woven with innumerable small stems, and has a low, thin,

uneven canopy; forest is clear near the ground, taller, shady, and contains a number of very large stems. These differences, surprisingly, are not manifested in the life form distribution of species within the habitats. They appear, rather, to rest on subtle differences in habit which are assumed within particular life forms. Climbers are the most notable in this regard; their plasticity of development under different light regimes has been discussed by Richards (1952, p. 105). Typical examples in Pinkwae include some of the most abundant climber species, especially Grewia carpinifolia, Capparis erythrocarpos, and Griffonia simplicifolia. In forest, these species develop large, unbranched or sparsely branched stems, which grow (with some meandering near the ground) to the canopy; there they produce a profusion of branches and foliage. In light-exposed conditions, such as those found in thickets or large gaps, they develop a dense, elaborately branched structure near the ground, climbing mainly on shrubs, or other climbers, or small trees; Capparis erythrocarpos and Griffonia simplicifolia are sometimes themselves rather shrubby in form. These differences in development pattern under varying light regimes are, incidentally, potentially quite useful in detecting past

gaps within apparently mature forest: densely branched stems of Grewia carpinifolia, for example, occur near ground level in some areas of Pinkwae which are now covered by a closed canopy, and such areas undoubtedly are the sites of old gaps.

Floristic Variation and Dynamics

An ordination of stands and species was done for the 0.01 ha plots within Pinkwae (Fig. 65). The species ordination shows a tight cluster of points near the centre of the diagram, made up of trees and climbers which are characteristic of undisturbed, closed canopy sites in the forest: Drypetes spp., Diospyros abyssinica, Tiliacora funifera, Hippocratea africana, Griffonia simplicifolia, and others. The species having extreme scores on the axes were mostly emergent, uncommon species which are characteristic of gap or marginal areas: Ceiba pentandra, Afraegle paniculata, Elaeophorbia drupifera, and Zanthoxylum xanthoxyloides. Climbers belonging to this group include Cissus petiolata, Acridocarpus smeathmannii, Asparagus warneckei, and Triclisia subcordata, all species of both thicket and forest. A zone of intermediate species was found between the extreme marginal species and those which form the closed-canopy nucleus: Cassipourea congoensis, Millettia thonningii, Lannea nigritana, Diospyros mespiliformis, and Ochna membranacea, as well as the shrubs Carissa edulis and Coffea ebracteolata. These species occur most frequently under disturbed canopy, possibly the sites of past small gaps.

Ordination diagram of stands and species within Pinkwae. Left-hand side, stands: plots are numbered (refer to Fig. 5b); plots having a disturbed or open canopy indicated by open circles; closed canopy plots indicated by filled circles. Right-hand side, species: filled circles, trees; open circles, climbers; half-filled circles, shrubs; stars, herbs.

Clumping of stands was evident in the ordination, but was less easily resolved. Plots which are close to one another geographically are often close floristically as well (stands 35, 36, 20, and 21; 16 and 17; 2, 3, and 4; 10, 11, 12, and 13; and others). Plots on the northern margin are mostly grouped at the high end of axis 3, although plots 20, 21, 35, and 36, in a relatively sheltered area of the margin, are not. The colour of soil in each plot is indicated in Fig. 66. Plots having black or blackish soil are separated floristically from plots with red or brown soil. Black soil plots typically have a low diversity of trees and seedlings, and particularly low seedling density. The principal (and sometimes only) species in the canopy are Diospyros abyssinica (often in high abundance), Drypetes parvifolia, and Drypetes floribunda; the herb Hillieria latifolia appears to be restricted to these blackish soils.

The close floristic affinity among closed canopy sites and the close distributional affinity among species characteristic of these sites (Diospyros abyssinica, Drypetes spp., and others) is notable. Pioneer species (or gap-exploiting species) are widely separated in distribution from one another: they tend to define opposite ends of the ordination axes. This suggests that while any

Ordination diagram of stands within Pinkwae (as in preceding figure). Soil colour in each stand indicated by symbols as shown in key. Plots with black soils separated from other plots on the first axis.

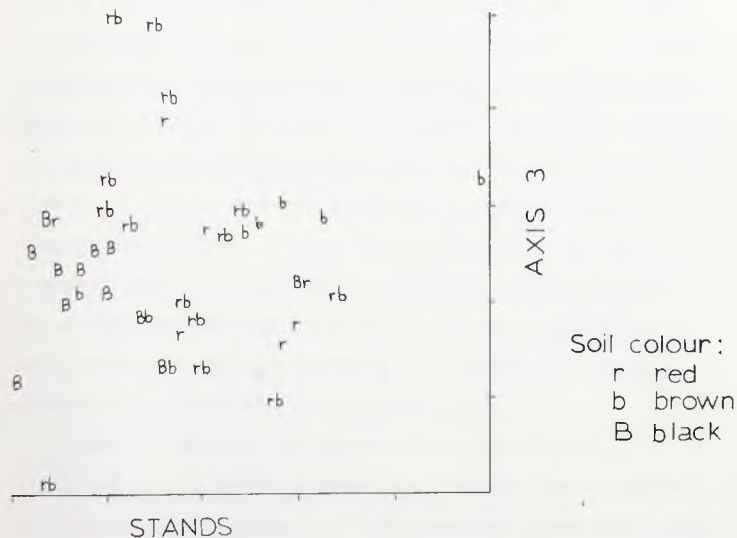

of several large emergent species may come to invade a gap or colonize a margin, different species do not appear to coexist within gaps. The species involved, principally Afraegle africana, Millettia thonningii, and Elaeophorbia drupifera (species of gaps and margins) and Ceiba pentandra and Zanthoxylum xanthoxyloides (of margins only), are rare within the forest and are strongly clumped in their dispersion pattern. It appears very likely that the emergent species which come to invade a gap in Pinkwae are determined largely by chance, and the probability of any particular species becoming established in a newly-formed gap is variable in time and space.

Many of the smaller species which occur under disturbed or incomplete canopy are somewhat more uniform in distribution, and many of them commonly co-occur within gap areas; these include the shrubs Coffea ebracteolata and Carissa edulis and the trees Erythroxylum emarginatum, Cassipourea congoensis, Baphia nitida, and Ochna membranacea. Most of these species are not, in fact, confined to gaps, although they are most frequently found where light levels are relatively high.

For each of the 0.01 ha plots within Pinkwae, two independent species lists were compiled from the record, one of all species of adults present, and the other of all juvenile species present. Adult climbers and trees were considered to be those over 3 m in height; adult shrubs were taken to be those of more than 1 m in height. While this was a rather arbitrary division, it was suitable for the purpose intended. The species and stands (now with two "stands" from each sample plot) were ordinated (Fig. 67). Adult and juvenile cohorts were separated on the first axis. This results from the rather large number of species which only occur in the samples as seedlings or saplings (Teclea verdoorniana, for example) or as adults (Ceiba pentandra, for example).

If local patches are maintaining themselves floristically, then a high positive correlation is expected between ordination scores of the adult (canopy) and juvenile (regenerating) cohorts in each plot. Figure 68 shows a scatter diagram of regeneration and canopy axis 2 scores (axis 2 was selected for this purpose because it had the best spread of points). There appears to be a wide scatter of points, some deviating considerably from the expected values. This indicates that local patches show floristic variation with time, rather than maintaining the same

Ordination of stands and species from 0.01 ha plots within Pinkwae (axes 1 and 2). Species lists of canopy cohort and regenerating cohorts (seedlings and saplings) prepared independently for each plot. Left-hand side, stand ordination: plots are numbered (see Fig. 5b); stars, seedling and sapling cohorts; circles, canopy cohort. Right-hand side, species ordination: circles, tree species; squares, climber species.

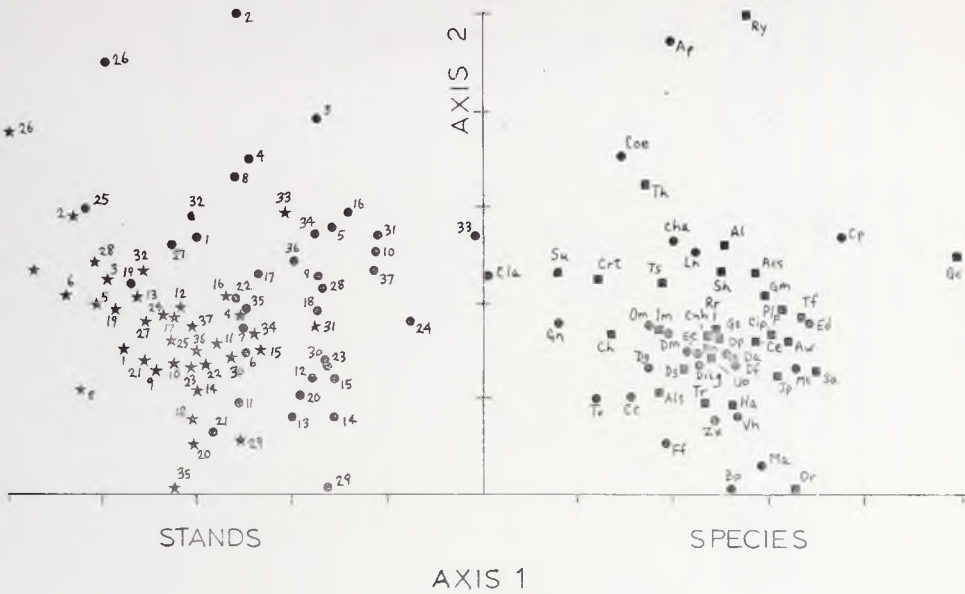

16576

Scatter diagram of axis 2 ordination scores of canopy species lists versus regeneration species lists in each 0.01 ha sample plot. Dashed line indicates the expected position of plots in which composition of the canopy species and regeneration species are identical. Plot numbers (refer to Fig. 5b) are indicated.

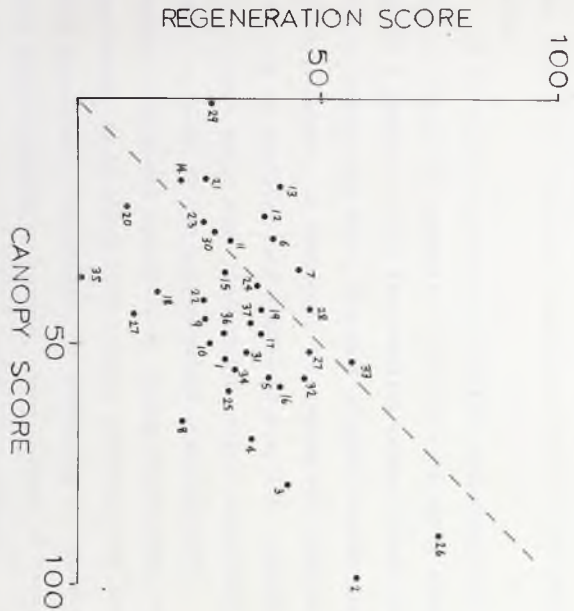

floristic composition. Of particular interest is the fact that the plots having black soil (dominated by Diospyros abyssinica and having very low diversity of trees and seedlings) do tend to fall on the expected line; this indicates that these plots are floristically stable.

If the overall pattern of relative abundances of species within the community is stable with time, then the rank of a species within the seedling cohort should be strongly correlated with the rank of that species within the adult cohort; in addition, the regression slope of tree rank on seedling rank should be near 1.0. Species with a lower adult rank (indicating greater importance: rank 1 is given to the most abundant species) than seedling rank would appear to be facing diminishing relative importance, while those with a lower seedling rank than adult rank would, conversely, be increasing in importance. (This line of reasoning ignores other sources of variation, including different rates of seedling mortality).

Using data pooled from the series of 0.01 ha plots, 24 species of trees were independently ranked according to their abundance (number of individuals) in both the seedling and tree cohorts. Figure 69 shows a scatter

Figure 69

Scatter diagram of seedling rank of each species versus adult tree rank of the same species. Low ranks correspond to high abundance. Ranking based on numbers of individuals. Solid line, calculated regression through data points: $y = 0.64x + 4.50$; $r = 0.633$, 22 d.f.; $P < 0.01$. Broken line, expected regression line in stable community.

Species abbreviations as follows: Dp, Drypetes parvifolia; Df, Drypetes floribunda; Da, Diospyros abyssinica; Ee, Erythroxylum emarginatum; Dia g, Dialium guineense; Vh, Vepris heterophylla; Ln, Lannea nigritana; Cha a, Chaetacme aristata; Dic g, Dichapetalum guineense; Cc, Cassipourea congoensis; On, Ochna membranacea; Cla a, Clausena anisata; Ed, Elaeophorbia drupifera; Gn, Gardenia nitida; Ma, Malacantha alnifolia; Bp, Baphia pubescens; Ff, Flacourtia flavescens; Cp, Ceiba pentandra; Ec, Ehretia cymosa; Dm, Diospyros mespiliformis; Ap, Afraegle paniculata; Zx, Zanthoxylum xanthoxyloides; Mt, Millettia thonningii; Bn, Baphia nitida.

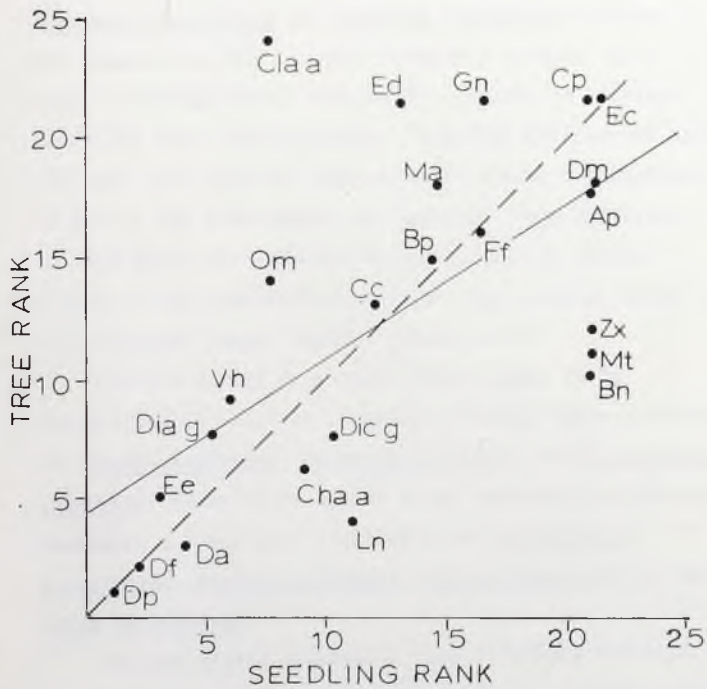

diagram of seedling rank versus tree rank for the 24 species. A significant correlation was found ($r = 0.633$, 22 d.f.; $P < 0.01$). The two most abundant species (Drypetes parvifolia and Drypetes floribunda) conform to the expectation for a stable abundance pattern (tree rank = seedling rank); the scatter appears to increase among the less common species. This may be expected among the very rare species, some of which differ in abundance by only a few individuals and therefore show differences in rank which are effected to some extent by chance. Chance is not expected to influence the ranking within the more abundant range, however (ranks 1-15).

Species within this range which appear to be diminishing in relative importance (having fewer seedlings) are Lannea nigritana, Chaetacme aristata, and Dichapetalum guineense; those which appear to be increasing in relative abundance (having more seedlings) are Erythroxyllum emarginatum, Dialium guineense, Vepris heterophylla, and Ochna membranacea.

The calculated regression line ($y = 0.64x + 4.50$) has a slope less than 1.0 (the expected slope in a stable community); it may be inferred from this that the relatively abundant species are in the process of becoming more abundant, and the relatively rare species are becoming more rare. This would suggest a process of decreasing

equitability (evenness) and hence decreasing diversity in the community. In the absence of confirmatory long-term assessments, of course, this must necessarily be a rather tentative conclusion.

An ordination was done on all the 0.01 ha plots within Pinkwae together with additional stands from other parts of the Accra Plains. The additional stands were from the following areas: two from thicket patches 15-30 m from the northern border of Pinkwae; one from a large, degraded thicket to the west of the Accra-Aburi Road near Madina; two from an area of large, severely degraded thickets east of Madina (see Fig. 4); two from areas of very large, partially isolated thicket clumps near the University of Ghana A.R.S., Nungua; one from a severely degraded thicket area on a hilltop overlooking Prampram on the coast; and several from small clumps, including two clumps to the south of the Accra-Tema Motorway, one clump in a low-lying area near Katamanso, and four clumps near Santeo. The ordination diagram is shown in Fig. 70 . There was a clear, complete separation on axis 1 of forest stands, large thicket stands, and thicket clump stands. These formations are thus

Ordination of stands and species from thicket and forest vegetation of the Accra Plains. Axes 1 and 3 are shown. Left-hand side, stand ordination: plots in forest, degraded thicket, and thicket clumps are separated. Soil colour indicated as follows - B, black; b, brown; r, red, br, brownish-red; g, grey; open circles indicate that soil colour is not known. Right-hand side, species ordination: closed circles, species which occur in forest only; half-filled circles, species found in forest and thicket; open circles, species occurring in thickets in the Pinkwae area, but not the forest; x, thicket species absent from the Pinkwae area.



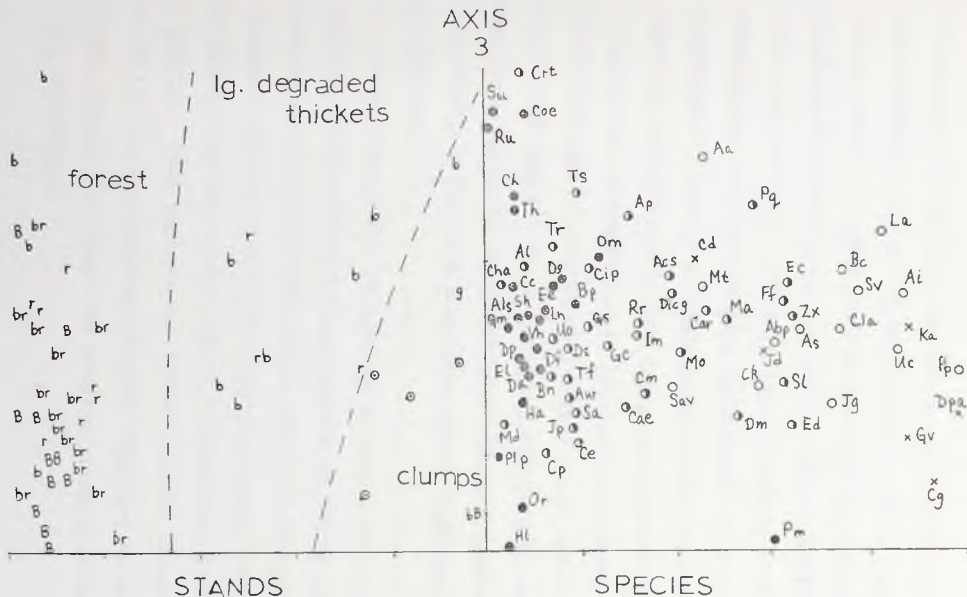

1991

floristically distinct, but represent a floristic gradient. Axis 3 appeared to be related to soil. The colour of soil in each stand for which it was recorded is indicated on the diagram; black soils are more or less isolated from other soil colours. Whether these represent nutrient differences, moisture-holding differences or other differences relating to topography is not clear, although there was a tendency for low-lying areas to have higher axis 2 values than elevated areas. Too little is known of the specific edaphic features which might be of importance here for further comment to be made, but the results suggest that investigations of soil-vegetation relationships on a microhabitat level on the Accra Plains might prove to be of interest.

Ordination scores of species on axis 1 were related to their habitat distribution in terms of forest, degraded thicket, and thicket clumps (Fig. 70). The species ordination did not result in sharp divisions between species groups, but rather showed a continuous gradient of species. Many species are found to occur in more than one of the above formations (forest, degraded thicket, and thicket clumps), although the habitat preferences are apparent in the ordination.

Dominance-diversity curves are produced when log-transformed frequency (or other importance values) are plotted against species rank. Species-poor, harsh plant communities show characteristic straight-line plots, while species-rich communities show log-normal (S-shaped) curves (Hubbell 1979). Dominance-diversity curves were plotted for species in Pinkwae, based on ranked frequency; the data used were the pooled results from the 0.01 ha plots (total 0.37 ha). Adult species were treated separately from seedling species, in order that the shape of the two curves (adults vs. seedlings) might be compared (Fig. 71). Although seedlings are more numerous, these curves are essentially identical. This suggests that the dominance relationships among species are comparable for seedling and adult cohorts. If interspecific competition is principally responsible for the relative abundances of species which are found in the canopy in Pinkwae, then such interactions appear already to have been influential at the seedling stage.

Log_{10} of frequency of species ranked from most to least abundant. Information from 37 plots of 0.01 ha each. Lower curve, adults; upper curve, seedlings (tree species, filled circles; climber and shrub species, open circles). Adults included trees over 3 m in height, climbers occurring within the canopy, and shrubs which had reached their usual maximum height. Seedlings were plants less than 1 m in height.

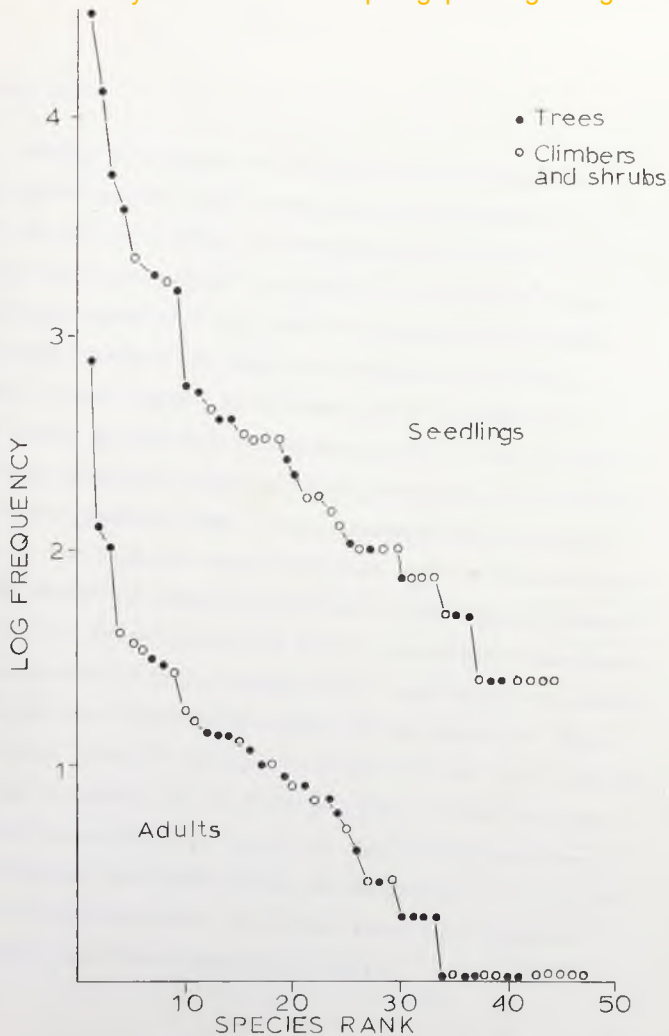

Forest Cover

Aerial photographs of the Pinkwae area taken in 1961 were compared with ground measurements made in 1976 and 1978, in order to determine whether the area of forest cover had changed perceptibly during that time. Slight increases in cover could be discerned in certain sheltered "pockets" of grassland along the northern margin. These changes were found (refer to Fig. 5b) in the deep pocket east of seedling plot T2, and in the two closed or partially closed pockets just west of the northern end of the transect line. Other measurements (in four areas on the northern margin and five areas on the southern margin) showed no changes which were significantly greater than the limits of resolution of the measurement techniques. The perception of those changes which were found was aided by the uniquely identifiable shape of the margin in those areas; mean rates of increase measured were on the order of 1-4 m in 16 years, or 10-30 cm per year. These certainly represent unusually high rates, as those areas were far more sheltered than other areas on the margin. Within the limits of resolution and the rather short time interval considered, the forest margin is stable.

Other wooded areas appearing on the aerial photographs were visited, in order that comparisons might be made between Pinkwae and nearby unprotected areas. Several large patches of vegetation (see Fig. 3) were found to have disappeared entirely in the 16 years since the photographs were taken. One area of thicket had been cleared for large-scale farming, and another was reduced by wood cutting and farming to low patches of scrubby thicket. Whether these may ultimately regenerate by means of root suckers is not known. Many smaller patches had been cut extensively for firewood and any canopy which they may have had has disappeared.

The rate of gap closure within Pinkwae is not known. Large gaps which are visible on the 1961 aerial photographs have not noticeably altered in size or shape since that time. These gaps, which are entirely filled by woody climbers and shrubs, have few or no saplings within them. Around the margin of the gap area which was mapped (see Fig. 60), there is an encroaching zone of very young trees (Lannea nigritana, Drypetes floribunda, and Diospyros abyssinica in particular). If this represents the initial stages in the colonization of the gap, the process must be exceedingly slow: this zone of small

trees is ringed, just behind, by a zone containing some of the largest trees which were mapped (especially Lannea nigritana, Diospyros abyssinica and one unusually large tree of Ochna membranacea). These large trees must be extremely old, and hence the gap margin must be quite stable. The absence of saplings of the expected light-demanding species - Millettia thonningii, for example - within the gap itself suggests that the interior of the gap may be unsuitable for sapling establishment, perhaps due to soil conditions or the very high level of exposure.

Small gaps of less than 100 m^2 (0.01 ha), in contrast, do show evidence of recolonization by saplings of many species, including Erythroxylum emarginatum, Ochna membranacea, Cassipourea congoensis, Drypetes spp., and, more rarely, Malacantha alnifolia, Diospyros mespiliformis, Gardenia nitida, and Lannea nigritana. Small gaps in different stages of regrowth are apparent throughout Pinkwae; these areas are considerably more diverse, in terms of the number of tree and climber species present, than are the more mature, closed canopy areas.

DISCUSSION

Phenology

Pinkwae occurs at the present climatic limit of forest development, in terms of annual rainfall and severity of the dry season. Not surprisingly, phenological patterns observed in Pinkwae are dominated by the low, uneven distribution of rainfall. Flowering, fruiting, leaf fall, flushing, and girth changes in the community were related to moisture conditions. It is not possible to distinguish with certainty between daylength and moisture as the cue which brings about these phenological changes, however, as rainfall and daylength are not independent of one another: rainfall peaks tend to coincide with daylengths of around 12 hrs 05 min. Evidence suggests that rainfall is not the cue for initiation of buds, as buds appear before the onset of rains, in Pinkwae and elsewhere (Longman and Jenik 1974). There were significant correlations between rainfall and flowering activity and between rainfall and flushing activity, however, and it is highly unlikely that these results, based on two years of records with 95 sampling dates and

80 species, are coincidental. Rainfall may be the final trigger for flowering and fruiting, following initiation of buds cued in some other way, perhaps by daylength. This explanation is consistent with all the observations on phenology made during this study.

The most likely explanation for the greater success rate of fruit set observed in dry-fruited than fleshy-fruited species would involve moisture considerations. The amount of moisture required to produce a fleshy fruit is clearly much greater than that needed to produce a dry fruit. It may be, therefore, that the internal moisture threshold below which fruit production would be suppressed is lower in dry-fruited species than in fleshy-fruited species. The failure or success of fruit set must be determined, it has been shown, at a very early stage, and thus before large expenditures of moisture have been made by the plant; this would appear to be a very conservative mechanism, but a successful one, inasmuch as the vast majority of fruit which was set did attain maturity.

The other factor which appears, on the basis of circumstantial evidence, to contribute to fruit set failure in the study area is inadequate pollen transfer, and

this may be the more important of the two. Medway (1972) has presented circumstantial evidence for occasional massive pollination failures in some species of lowland tropical forest in Malaya. Insect activity is itself a seasonal phenomenon, and the success of fruit set in insect-pollinated plants may depend upon a number of things: the presence of an adequately large resident insect population or the ability of the plant to attract one from some distance; the availability of nearby sources of compatible pollen; and the absence of competition from other plants for the appropriate pollen vectors (Frankie 1975, Frankie 1976, Frankie et al. 1976, Janzen 1977, Stiles 1977). Information concerning these factors in the study area is not available; similarly, there is little or no information on the breeding systems of the species involved, and such information would be necessary for any comprehensive understanding of plant-pollinator interactions and pollination success.

Harper (1977) has pointed out that as species approach the limits of their range, hazards to life (climatic ^{and} biotic) become more frequent; this will be reflected in the reliability of the seed output. While there may be no real advantage to a steady, reliable seed

output in long-lived plants (Harper 1977, Janzen 1978), a large seed crop does reflect a condition of vigour.

Synchrony within species was relatively high with regard to reproduction, leaf behaviour and girth changes. This suggests either that the cues are direct, environmental stimuli, or that endogenous rhythms are reliably "re-set" within the population due to the environmental extremes which occur at Pinkwae. It has been observed elsewhere that more extreme seasonal environments produce greater within-population synchrony (Frankie et al. 1974^a). Exceptions to the pattern of synchrony are Antiaris africana, Ceiba pentandra, and a few others, which showed poor synchrony within populations and within the individual as well - different branches appear to have independent endogenous rhythms.

Temporal partitioning of physiological functions within the plant is subject to selection; the timing of phenological changes thus involves responses to proximate factors (immediate environmental cues), these responses themselves being the outcome of ultimate factors

(the evolutionary consequences of past selection). It is possible to consider the probable ultimate factors leading to the phenological patterns which are found at present in Pinkwae. The timing of flowering and fruiting appears to be primarily related to problems of pollination and seed dispersal rather than to physiological considerations. Reproductive phenological patterns were consistent among groups having similar seed dispersal mechanisms, and belonging to similar synusiae.

Leaf phenology, on the other hand, appears to be closely related both to physiological factors (dehydration) and biotic factors (leaf predation). Flushing (synchronous leaf production) was shown to be of adaptive value in the study area; survivorship of asynchronous leaf crops was lower than that of synchronous crops, except where other predation defence mechanisms (such as hairs or deterrent chemicals) were present.

The amplitude of the annual girth cycle in trees was found to be related to the habitat of the species: high amplitudes were found in more exposed habitats. Microclimate observations indicate that inter-habitat

differences in temperature and relative humidity are slight. Wind-speed, on the other hand, which can have a profound influence on rates of evapotranspiration, does differ markedly between open grassland and the forest canopy, and between the forest canopy and the understorey. In addition, soil drying may be slower under a closed canopy than under a patchy thicket canopy or in open grassland.

Differences between species in the girth change pattern may also be expected to result from different adaptive strategies of water conservation and metabolism (Bunce et al. 1977); the fact that patterns were relatively consistent within habitats suggests that species co-occurring in certain habitats may share similar strategies of water conservation.

Using the available data, it is not possible to distinguish between girth changes resulting from woody growth and girth changes brought about by variation in moisture status. It is considered likely that the latter source of variation was the more important in these trees during the study period; either woody growth was suppressed by the level of moisture stress, or changes resulting from woody growth were swamped by variation due to moisture stress. Passive changes in wood volume occur in response to changing moisture status even in dead wood, and changes of this sort could have contributed to the observed girth changes.

A possible explanation for the lack of a girth-specific response in Lannea nigritana may be that, to the extent that root connections are maintained within the clone (or clones), the physiological status or response of individual stems may not be independent of that of other such stems; the moisture status of interconnected trees may, in fact, be "averaged out" in some way within the clone. This species has a rather spongy wood with very thick, soft bark, and soft leaves which wilt rapidly after cutting, and it showed a relatively wide range of mean girths during the year; the species would therefore

be expected to show a strong girth-specific girth response if stems responded independently.

The girth increment figures obtained for the 1978-79 year are clearly atypical; this was a particularly dry year (see Fig. 19), and it is most likely that the growth rates of trees in Pinkwae are strongly moisture-dependent. In order to obtain a useful estimate of mean annual girth increment for these trees, one should have information of this type collected over a period of several years, including both wet and dry years.

It should be mentioned that it is possible, although unlikely, that the choice of reference peaks could have affected the results; using several years' records on these trees, one might be able to identify other peaks satisfactorily, which could then be used for comparisons between years.

It can safely be concluded, however, that moisture conditions such as those of 1978-79 at Pinkwae are wholly inimical to the growth of dry forest trees, and it may be further predicted that where such conditions prevail over protracted periods, dry forest would not develop or be maintained. Even those species (Antiaris africana, Lannea acida, and Millettia thonningii) which,

in the Pinkwae area, typically occur in grassland or thicket clumps outside the forest were similarly affected.

Regeneration

An overall decrease in seedling density was observed during the study period. The wet season increase in new seedlings was insufficient to replace seedlings which died throughout the year. The thinning in thicket clumps resulted in an increase in species equitability (evenness), however, while that in forest resulted in decreased evenness; this indicates that competition (or differential survivorship) among seedlings is a greater influence in the species composition in forest than in thicket.

The results of the soil seed stock experiments indicate that little inter-habitat mixing occurs in the seed rain. All the dispersal mechanisms represented by species in the samples showed high rates of intra-habitat seed delivery. Although no significant difference could be demonstrated, species dispersed by animals appeared to have somewhat better intra-habitat delivery rates than other species; it is possible that larger sample sizes would resolve this. It is, in fact, to be expected that animal dispersal should lead to adult/seed habitat constancy; birds and small mammals do tend to remain within habitat patches of a particular kind, feeding there and dispersing seeds there. Thus animal-dispersed seeds would tend to be dispersed in appropriate patches of habitat, whether the animal spat out or regurgitated the seed in the neighbourhood of the parent plant, or swallowed the seed and defaecated it at some distance from the parent. The optimal seed shadows of these plants are entirely unknown; however, it would appear likely that within an isolated, undisturbed, coarse-grained mosaic community of the kind found near Pinkwae, within-habitat seed dispersal would be selectively favoured.

In addition to the small herbs which have no obvious dispersal mechanism, many large, woody species in the Pinkwae area have been observed to drop their fruits or seeds directly to the ground without the intervention of an animal dispersal agent or other dispersal mechanism. This has been seen commonly in Afraegle paniculata, which bears heavy, globose, fleshy fruits about 10 cm in diameter, and Drypetes floribunda, Tiliacora funifera, and Grewia carpinifolia, all with smaller, edible fruits. Scatter-boarding or other animal dispersal may still occur after the fruits are dropped, of course, which would also tend to maintain adult seed habitat constancy. Jackson and Gartlan (1965) have shown that seed dispersal patterns of monkeys tend to maintain the integrity of thicket clumps.

In recent experiments comparing the seeds in soils from geographically and floristically widely-separated forest types in Ghana, Hall and Swaine (1979^b) found general similarity in the seed stocks from different forest types - much greater similarity than was shown for the forest types themselves. The similarity among seed stocks was attributed to the high proportion of pioneer, secondary forest species among the seedlings; these

species are more widespread geographically than are species of mature forest, and often have effective long-distance dispersal mechanisms; they are thought, in addition, to have relatively long-lived seeds which may remain for some time in the soil until their dormancy is broken by exposure.

While most of the species which germinated from the Pinkwae soil samples did so under exposed rather than shaded conditions, they do not comprise a secondary type of flora - that is, they are not predominantly components of transient, successional habitats.

Most species which germinated from the soil samples were relatively common in the study area. An interesting exception to this is the thicket and secondary forest species Trema orientalis, which appeared in both the forest and thicket clump soil samples, but which has not been found growing around Pinkwae. This species, which is bird-dispersed, germinated in soils of all six Ghanaian forest types considered by Hall and Swaine (1979^b), as well as from Nigerian (Keay 1960) and Malaysian (Liew 1973) forest soils.

The relative absence of secondary seed species in the forest soil in Pinkwae, as compared with findings of

Hall and Swaine (1979 b) is intriguing, and probably relates both to (1) the observed lack of inter-habitat mixing in seed dispersal and (2) the geographical isolation of this forest from other forests, and in particular, from forests which might contain typical secondary species. It has been observed (J.B. Hall, pers. comm.) that the dry forest outliers of the Accra Plains do not themselves support a secondary forest flora of the kind associated with gaps and regenerating patches throughout the forest zone in Ghana. Such species are adapted to growing rapidly in fully or partially exposed conditions - conditions which strongly suppress the growth of primary wet forest species (Richards 1952). Dry forest trees are themselves relatively exposure-tolerant (forest on the Accra Plains has a relatively thin canopy, and the deep shade characteristic of wetter forests is never seen); it may be that secondary forest species cannot compete successfully with the mature dry forest species. Alternatively, secondary species may require higher rainfall than is found on the Accra Plains.

Seeds vary in the length of time which they remain viable, and this is reflected in the seed stocks which accumulate in the soil: seed stocks will tend to be

biased in favour of long-lived seeds (Grubb 1977, Hall and Swaine, 1979^b). Large seeds are typically short-lived, lacking a period of dormancy (Hall and Swaine, 1979^b); these are generally shade-tolerant seeds characteristic of mature forest (Salisbury 1974). Harper (1977) has remarked that forest seeds do not normally accumulate in the soil. It is possible that the few seeds which germinated from the Pinkwae forest soil samples (most of which were from large-seeded species) were all new arrivals, the older seeds having germinated at once rather than lying dormant and accumulating in the soil.

Thompson and Willson (1978) found that the disappearance of ripe, fleshy fruits due to bird feeding was faster and more thorough around forest gaps and margins than under closed-canopy forest. The margin and gap areas in Pinkwae had both more bird species and activity (M. Lieberman, pers. comm.) and more abundant and diverse fruiting than did the areas of closed-canopy. Dispersal of seeds by birds is therefore probably somewhat reduced in closed-canopy areas, and this could have contributed to the poorer seed stocks found.

Root suckers were found to be more important in thicket clumps than in forest, both in terms of the density of individuals and the number of species. The fact that root suckers arise near the "parent", and are thus likely to be in a suitable habitat for establishment, should be particularly important where the thicket clumps form small, isolated patches within a larger area of inhospitable grassland. Although within-habitat seed dispersal by animals may bias the pattern, it is expected that the probability of a seed reaching a suitable habitat in a patchy environment is a simple function of the relative abundance of that habitat in the mosaic. As thicket clumps become smaller, therefore, the probability of successful seed dispersal should diminish, and root suckering should become more important.

In addition, the provision of parental resources - especially moisture and photosynthate - enhance the competitive ability and hence the probability of establishment of the young suckers; the relatively high density of competitively superior root suckers may thus contribute to the difficulties seedlings encounter within thicket clumps. It is my impression that mortality in root suckers is far lower than in seedlings, although the

available data on root suckers are insufficient to support or refute this.

Although definitive information in this regard is lacking, one may suppose that in a clonal species, such as Lannea, young individuals would arise predominantly in sites suitable for establishment - that is, initiation of a root sucker bud might be stimulated by a microclimatic regime characteristic of light gaps, for example; and it is further possible that localisation of the bud along the root might be fairly precise in relation to the relevant microclimatic gradient. This would bring about a less wasteful and more conservative regeneration pattern than that found in seeding species, and, to the extent that it might apply to Lannea, it could account for both the low numbers of young suckers in the population and the rather high survivorship rates among members of the larger size classes.

Root suckering is stimulated by cutting or other tissue damage. For this reason, thickets which are extensively cut for firewood may reappear in a short period of time within the old margins, a feature which permits thicket survival in the face of human disturbance. Cut-over thicket areas are certainly not readily invaded by savanna grasses, and hence are not likely to be transformed rapidly into open grassland.

A number of species which occur in the Pinkwae area only in thicket are found to occur in closed canopy forest in the moister parts of the forest zone of Ghana (J.B. Hall and M.D. Swaine, pers. comm.). These include the large trees Antiaris africana and Ceiba pentandra (which only grow to a fraction of their usual forest zone height in the Pinkwae area), and the climbing shrub Byrsocarpus coccineus. Antiaris africana and Byrsocarpus coccineus regenerate adequately in thicket, but fail to establish seedlings within Pinkwae; seedlings occasionally germinate in forest sites which have high light levels, but they die within 2-4 months. Seedlings of Ceiba pentandra have not been seen in the Pinkwae area. It seems certain that moisture is the limiting resource for Antiaris africana and Ceiba pentandra in Pinkwae; root competition among trees is no doubt more severe in forest than in smaller thicket areas (which have fewer trees and a less fully-packed rhizosphere). Thus these species and others limited by moisture might be better able to survive on the margins of forest or in thickets than in closed-canopy dry forest; given a set of moisture-limited species, it may further be the case that small

thickets or elongate thickets (having a large perimeter: area ratio) are the most stable configuration which the vegetation can assume.

Questions posed by Richards (1952, p. 40) with regard to tropical forest demography include the following: at what stage does the heaviest mortality occur (and hence the most intense natural selection)? What is the normal age-class distribution of undisturbed rain forest trees? And what is the average age at death of trees in different strata? It is possible to consider some of these questions for dry tropical forest, based on results reported here. The size class distribution of a population is indicative of its size-specific survivorship curve. The size class information presented reveals that many of the tree species in Pinkwae have a relatively constant mortality rate through the first several size classes (up to 20% of the maximum basal area attained by the species), and others have a constant mortality rate through the entire lifespan of the tree (Erythroxylum emarginatum and Dichapetalum guineense). This rather surprising conclusion is based upon reliable censuses

in all size categories, collected over an adequately large sampling area to average out site differences. It is possible that higher mortality rates occur in very small seedlings: because all seedlings less than 1 m in height were pooled for this analysis, however, changes in the mortality rate within that size class would be beyond the limits of resolution.

While age information is unfortunately lacking, it has been shown that size distribution patterns vary considerably from one species to the next. Lannea nigritana, a gap-exploiting emergent tree which reproduces in Pinkwae solely by root suckering, has a highly irregular size distribution, with peaks of abundance perhaps related to episodes of gap invasion. Species of closed canopy areas have rather similar distributions with one another; with good stocking in all size classes. Some rare, marginal species (Baphia nitida, Millettia thonningii, and Afraegle paniculata) appear to lack seedlings altogether.

Dynamics

Possible explanations for the observed clumping can readily be adduced. Millettia thonningii, Lannea nigritana, and Dichapetalum guineense regenerate freely by means of root suckers. Chaetacme aristata produces abundant epicormics and coppice shoots, and probably develops root suckers as well. Lannea nigritana and Millettia thonningii both have large, spreading root systems, while Dichapetalum guineense does not; this might explain the lower modal nearest neighbour distance in this species.

Seed dispersal patterns may contribute to the dispersion pattern in some of the species. Millettia thonningii, in addition to root suckering, reproduces by means of explosively dispersed seeds, which can travel a maximum distance of 20-30 m in the open, and probably considerably less within the forest (Swaine and Beer 1977). All the other clumped species have animal-dispersed fleshy fruits. Drypetes floribunda produces large synchronous crops of tasty caulicarpous fruits, about 1.5 cm in diameter. Some of the fruits are eaten by various animals, but much of the crop is left to drop to the ground under the parent tree.

These are sometimes scatter-hoarded subsequently by small mammals, which would tend to maintain the clumping. Erythroxylum emarginatum reproduces exclusively from seeds, and the marked clumping in this species may result from either a narrowly defined micro-habitat preference (related perhaps to light conditions) or to the clumped deposition of large numbers of seeds by dispersal agents. The fruits of this species are about 1 cm x 0.5 cm, with a small amount of flesh around the seed; they are probably dispersed by birds and mammals. It has been observed that the distribution of seedlings and saplings of this species is also very patchy in Pinkwae, some small areas having seedling densities in excess of 50 m^{-2} .

Large trees of Diospyros abyssinica have very low densities of seedlings beneath them, and a high proportion of the seedlings which do grow there are Diospyros abyssinica. Whether other species are excluded because of the rather deep shade cast by the parent trees or because of a chemical exudate from the roots or leaves is not known, but the latter explanation is possible and deserves further attention. The leaves of this species are rich in naphthoquinones, which tend to be labile,

and could be leached into the soil from fallen leaves (Hegnauer 1966). The soil beneath old Diospyros abyssinica trees, as mentioned earlier, appears to be blacker and coarser than soil elsewhere in the forest.

Lannea nigritana appears to be moderately but not strongly clumped in this plot. The species clearly does occur in patches within the forest, but the patches are rather large in relation to the area which was mapped; this would reduce the appearance of clumping. The hyper-dispersion of Lannea within patches probably results from close control over the location of root suckers due to within-genet competition for resources; suckering may be competitively inhibited near the "parent" trunk. Production of basal shoots in this species was, in fact, never observed.

Drypetes parvifolia is not significantly clumped; the low mean value and markedly truncated frequency distribution of nearest neighbour distances results from its very high density: that is, the probability of encountering another individual of the same species nearby is very high.

The high diversity (H') coupled with low density found within the gap probably results from the relative absence of competition among the trees present; the individual crowns were seldom in contact, and mutual shading would not have occurred. The diversity remained quite high even with very high tree density in the next subsample, 0-5 m from the gap margin. This subsample and the adjacent one at 5-10 m from the gap margin represent a steep gradient of light, temperature, crowding, and so forth over a fairly short interval of space, presenting a wide range of micro-habitats which might be favoured by a large number of species (Strong 1977). At greater distances from the gap, the competition among trees for light, as well as other resources, would be far greater, and conditions would tend to be less varied over a large area; this might bring about the observed decrease in diversity.

The pattern of successional dynamics of species in Pinkwae follows a chronic, patchy disturbance model (Horn 1976). Evidence of convergence, in the absence of disturbance, on a low-diversity Diospyros abyssinica forest was found. Large, stable gaps are also a feature

of this forest. The presence of more or less permanent gaps has been recorded in Canadian boreal forests by Rowe (1961), who states that such areas do not return through an inevitable cycle, but rather tend to remain open, ragged, and bush-filled.

The relative abundance of a particular organism in a community is expected to be related to both the reproductive capacity of the organism (Darwin 1859) and the abundance of habitable sites which are available to it (Harper 1977). Most of the tree species which occur in Pinkwae are relatively rare there, and many are predominantly gap-exploiting species. A similar over-representation of uncommon, gap-exploiting species in the species list was noted by Hartshorn (1978) working in Costa Rican forest. Gaps appear to be formed infrequently in Pinkwae, and this limits the rate at which suitable habitat becomes available for colonization. Rare species in Pinkwae generally ^{have} poor reproductive output (at least during the study period) as well as being constrained by narrowly-defined, infrequently met, establishment requirements. The common species (Drypetes spp. and Diospyros abyssinica) generally occur in closed canopy areas, but can also colonize somewhat open areas; these

species produce abundant offspring.

Gap-exploiting emergent species were found to be widely separated from one another in the ordination of stands and species within Pinkwae; they are seldom found together in the same gap area. Whether the important factor in the establishment of one species rather than another is the proximity of a seed source, the time of last seeding, or some other factor is not known. The colonization of gaps by nearly pure stands of any of several secondary species has been observed by Whitmore (1978), who suggests that the seeds which fall into a gap first after its formation grow up to fill the gap. The pattern observed by Whitmore, and that observed here, would not be expected to arise if there were a uniform seed rain of pioneer species such as there appears to be in other Ghanaian forests (Hall and Swaine 1979^b). The absence of a typical secondary seed rain has been discussed elsewhere in this thesis. Some of the gap invaders in Pinkwae have shown irregular fruiting and others have inefficient seed dispersal mechanisms; this would contribute to the patchy nature of gap regrowth.

Pinkwae and the surrounding thicket areas occupy an ecotone: the southern forest-savanna boundary. Investigations of the northern forest-savanna boundary have indicated that its position is governed by climatic and edaphic factors (Swaine et al. 1976). The position of the ecotone in the south is probably controlled principally by rainfall. The north-south rainfall gradient on the Accra Plains corresponds well with north-south gradients in extent of woody cover, stature of woody cover (forest, continuous thicket, or thicket clumps), and floristics. The recent drought on the Plains may very likely have brought about regression of thicket clumps, as suggested by Okali et al. (1973).

Where forest is found on the Accra Plains, it occupies low hills of around 200 ft elevation (60 m) (Pinkwae and surrounding patches) or inselbergs (Shai, Krobo, and others). Forest outliers in the savanna north of the forest zone of Ghana are also confined to hilltops of around 150 m elevation above the surrounding Afram Plains (Swaine et al. 1976). The forest outliers of northern Nigeria, termed kurame, are confined to hilltops as well (Jones 1963). The latter occur under conditions of higher rainfall than Pinkwae, but resemble Pinkwae to some extent

floristically; species in common include Malacantha alnifolia, Millettia thonningii, Lannea nigritana, and others. Kurame probably owe their existence in part to protection by villagers.

Pinkwae and all other patches of woody vegetation in the subscarp area of the Accra Plains are equally subject to the influence of fire and wind - both likely agents of vegetation change. Yet Pinkwae differs from the neighbouring vegetation in obvious ways, including cover area, stature, physiognomy, and floristics. The protection of Pinkwae during the past 150 years from wood cutting has clearly been both necessary and sufficient to prevent its degradation from forest to thicket.

Oral tradition suggests that Pinkwae, at the time of the Battle of Katamanso, was mature closed-canopy forest, and, indeed, the botanical evidence seems to corroborate it: many of the large trees now in the canopy are almost certainly well over that age. The ban on cutting following the battle did not, therefore, bring about the development of forest on the site, but merely maintained it. The question then remains as to whether thickets now present on the Accra Plains could themselves become forest, were they to be protected from wood cutting. The answer may be inferred, at least in part, from the present behaviour of forest and thicket around Pinkwae.

The primary effect of wood cutting on forest or thicket is the removal, usually selective, of various trees and shrubs.

The secondary effect, which may be the more critical of the two, is the drastic alteration of the microhabitat and microclimate which follows removal of the canopy (Richards 1952). Large trees are, naturally, favoured for cutting. (I have seen no indication that the few very large trees growing in thickets in the vicinity of Pinkwae - mainly Antiaris africana and Albizia glaberrima - are excluded from cutting, as are, for example, large shade trees growing in cultivated fields; several of the large Antiaris trees which were fitted with dendrometer bands were, in fact, felled during the study period.) The removal of this canopy causes an increase in the range of temperature and relative humidity, increased wind velocity (and hence drying), and increased evaporation from the soil. In a habitat which already tends to be moisture deficient, this may be expected to cause the elimination of less drought-tolerant species. It is significant that one "pioneer" species of thicket clumps on the Accra Plains, Capparis erythrocarpos, which grows commonly within or on the outskirts of thickets and even

in open grassland, has large roots extending to a depth of 1.6 m (Okali et al. 1973); seedlings of this species, which germinate in light or shade, quickly develop a long, thick root as well.

The development of dry forest from thicket would depend upon the influx and establishment of seedlings of forest species into thickets. Evidence from Pinkwae indicates that seedlings of forest species do not generally occur in thicket clumps. There are several factors contributing to this: first, forest seeds are not usually dispersed into thickets; habitat constancy between forest and thicket species is significant, as was shown by the soil seed stock experiments. Second, such seeds do not often germinate, probably because of extremes of temperature and light; lacking a period of dormancy, they are likely to perish. Third, those seedlings of forest species which do germinate in clumps tend to die at a fairly early stage (long before they reach a metre in height); I have presumed that they suffered from root competition or moisture stress, although no information on this is available.

The trees which would comprise a forest flora elsewhere on the Plains, should such arise, are presumed to

be principally those found in Pinkwae; dominant species, judging from the composition of other forest outliers on the Plains, might be Drypetes spp., Diospyros spp., Dichapetalum guineense, Millettia thonningii, and Dialium guineense, among others. Under present climatic conditions, these species and others in Pinkwae were found to exhibit signs of severe and nearly constant moisture stress. They produced feeble amounts of flowers and fruits, they continued to accrue girth deficits during most of the year, and they showed a net loss in girth for the period of measurements. Seedling growth was slow, and mortality exceeded recruitment. While these observations were admittedly made during a particularly dry period, it must be remembered that the rainfall at Pinkwae is, on the whole, higher than that occurring in more southern parts of the Plains; thus rainfall would have to be considerably higher for forest species to become established elsewhere on the Plains.

REFERENCES

- Addicott, F.T. & Lynch, R.S. (1955). Physiology of abscission. Ann. Rev. Pl. Physiol. 6, 211-238
- Alvim, P. de T. (1964). Tree growth and periodicity in tropical climates. The Formation of Wood in Tropical Trees (Ed. by M.H. Zimmermann). Academic Press, N.Y.
- Ashton, P.S. (1969). Speciation among tropical forest trees: some deductions in the light of recent evidence. Biol. J. Linn. Soc. 1, 155-196.
- Aubréville, A. (1938). La forêt coloniale: Les forêts de l'Afrique Occidentale Française. Ann. Acad. Sci. Colon., Paris 9, 1-245.
- Aubréville, A. (1950). Flore Forestière Soudano - Guinéenne. Paris.
- Baker, J.R. & Baker, I. (1936). The seasons in a tropical rain-forest (New Hebrides) Part 2. Botany. J. Linn. Soc. (Zool.) 39, 507-519.
- Barua, D.N. (1969). Seasonal dormancy in tea (Camellia sinensis L.). Nature 224, 514.
- Beard, J.S. (1944). Climax vegetation in tropical America. Ecology 25, 127-158.

- Beard, J.S. (1946). The natural vegetation of Trinidad. Oxford For. Mem. No. 20.
- Black, G.A., Dobzhansky, Th. & Pavan, C. (1950). Some attempts to estimate species diversity and population density of trees in Amazonian forests. Bot. Gaz. **111**, 413-425.
- Bondeson, E. & Smit, A.F.J. (1972). Holocene tectonic activity in West Africa dated by archaeological methods: discussion. Geol. Soc. Amer. Bull. **83**, 1193-1196.
- Booth, A.H. (1958). The Niger, the Volta and the Dahomey Gap as geographic barriers. Evolution **12**, 48-62.
- Booth, A.H. (1959). On the mammalian fauna of the Accra Plains. J. West Afr. Sci. Assoc. **5**, 26-36.
- Brammer, H. (1967). Soils. Agriculture and Land Use in Ghana. (Ed. by J.B. Wills). London and Accra.
- Brown, W.H. (1919). Vegetation of Philippine Mountains. Manila.
- Bunce, J.A., Miller, L.N. & Chabot, B.F. (1977). Competitive exploitation of soil water by five eastern North American tree species. Bot. Gaz. **138**, 168-173.
- Burgess, P.F. (1972). Studies on the regeneration of the hill forests of the Malay Peninsula. The phenology of Dipterocarps. Malay. Forest. **35**, 103-123.

- Carleton, T.J. & Maycock, P.F. (1978). Dynamics of the Boreal forest south of James Bay. Canadian J. Bot. 56, 1157-1173.
- Census Office, Govt. of Ghana (1972). 1970 Population Census of Ghana. Vol. II. Statistics of Localities and Enumeration Areas. Accra.
- Clark, P.J. & Evans, F.C. (1954). Distance to nearest neighbor as a measure of spatial relationships in populations. Ecology 35, 445-453.
- Clements, F.E. (1916). Plant succession: an analysis of the development of vegetation. Carnegie Inst. Wash. Publ. 242.
- Connell, J.H. (1971). On the role of natural enemies in preventing competitive exclusion in some marine animals and in rainforest trees. Dynamics of Populations (Ed. by P.J. den Boer and G.R. Gradwell). Oosterbeek, Netherlands.
- Connell, J.H. (1972). Community interactions on marine rocky intertidal shores. A. Rev. Ecol. Syst. 3, 169-192.
- Connell, J.H. (1978). Diversity in tropical rainforests and coral reefs. Science 199, 1302-1310.
- Corner, E.J.H. (1940). Wayside Trees of Malaya. Govt. Printer, Singapore.
- Coster, C. (1926). Periodische Blüteerscheinungen in den Tropen. Ann. Jard. bot. Buitenz. 35, 125-162.

- Croat, T.B. (1969). Seasonal flowering behavior in central Panama. Ann. Missouri Bot. Gard. 56, 295-307.
- Darwin, C. (1859). The Origin of Species. Harvard Facsimile First Edition, 1964.
- Daubenmire, R. (1968). Plant Communities. Harper & Row, New York.
- Daubenmire, R. (1972). Phenology and other characteristics of tropical semi-deciduous forest in north-western Costa Rica. J. Ecol. 60, 147-170.
- Dawkins, H.C. (1956). Rapid detection of aberrant girth increments of rain forest trees. Emp. For. Rev. 35, 3-8.
- Drury, W.H. & Nisbet, I.C.T. (1971). Inter-relations between developmental models in geomorphology, plant ecology, and animal ecology. Gen. Syst. 16, 331-368.
- Emlen, J.M. (1973). Ecology: An Evolutionary Approach. Addison-Wesley, Reading, Mass.
- Fogden, M.P.L. (1972). The seasonality and population dynamics of equatorial forest birds in Sarawak. Ibis 114, 307-343.
- Foster, R.B. (1977). Tachigalia versicolor is a suicidal neotropical tree. Nature 268, 624-626.
- Fox, J.E.D. (1972). The Natural Vegetation of Sabah and Natural Regeneration of Dipterocarp Forests. Ph.D. Thesis, Univ. of Wales.
- Frankie, G.W. (1975). Tropical forest phenology and pollinator - plant coevolution. Coevolution of Animals and Plants (Ed. by L.E. Gilbert & P.H. Raven). Univ. of Texas Press, Austin.

- Frankie, G.W., Baker, H.G. & Opler, P.A. (1974)^a. Comparative phenological studies of trees in tropical wet and dry forests in the lowlands of Costa Rica. J. Ecol. 62, 881-919.
- Frankie, G.W., Baker, H.G. & Opler, P.A. (1974)^b. Tropical plant phenology: applications for studies in community ecology. Phenology and Seasonality Modeling. (Ed. by H. Lieth), Springer-Verlag, New York.
- Frankie, G.W., Opler, P.A. & Bawa, K.S. (1976). Foraging behaviour of solitary bees: implications for outcrossing of a neotropical forest tree species. J. Ecol. 64, 1049-1057.
- Gibbs, D.G. & Leston, D. (1970). Insect phenology in a forest cocoa-farm locality in West Africa. J. appl. Ecol. 7, 519-547.
- Goff, F.G. (1968). Use of size stratification and differential weighting to measure forest trends. Amer. Midl. Naturalist 79, 402-418.
- Goff, F.G. & Zedler, P.H. (1972). Derivation of species succession vectors. Amer. Midl. Naturalist 87, 397-412.
- Greig-Smith, P. (1969). Application of numerical methods to tropical forest. Statistical Ecology (Ed. by G.P. Patil, E.C. Pielou and W.E. Waters). Pennsylvania Univ. Press.

- Grubb, P.J. (1977). The maintenance of species-richness in plant communities: the importance of the regeneration niche. Biol. Reviews 52, 107-145.
- Gutterman, Y., Witztum, A. & Evanari, M. (1967). Seed dispersal and germination in Blepharis persica. Israel J. Bot. 16, 213-234.
- Haines, B. & Foster, R. (1977). Energy flow through litter in a Panamanian forest. J. Ecol. 65, 147-155.
- Hall, J.B. & Swaine, M.D. (1976). Classification and ecology of closed-canopy forest in Ghana. J. Ecol. 64, 913-951.
- Hall, J.B. & Swaine, M.D. (1979). Seed stocks in Ghanaian forest soils. Biotropica (in press)
- Hall, J.B. & Swaine, M.D. (1979). Distribution and Ecology of Vascular Plants in the Forest of Ghana. Ghana Univ. Press, Accra (In press)
- Harper, J.L. (1969). The role of predation in vegetational diversity. Diversity and Stability in Ecological Systems. Brookhaven Symp. Biol. 22, 48-62.
- Harper, J.L. (1977). Population Biology of Plants. Academic Press, London.
- Harper, J.L. & Benton, R.A. (1966). The behaviour of seeds in soil, Part 2. The germination of seeds on the surface of a water supplying substrate. J. Ecol. 54, 151-166.

- Harper, J.L. & Obeid, M. (1967). Influence of seed size and depth of sowing on the establishment and growth of varieties of fiber and oil seed flax. Crop Sci. 7, 527-532.
- Harper, J.L. & Sagar, G.R. (1953). Some aspects of the ecology of buttercups in permanent grassland. Proc. Weed Control Conf. 1, 256-265.
- Harper, J.L., Williams, J.T. & Sagar, G.R. (1965). The behaviour of seeds in soil, Part 1. The heterogeneity of soil surfaces and its role in determining the establishment of plants from seeds. J. Ecol. 53, 273-286.
- Harrison Church, R.J. (1963). West Africa (4th Edition). London.
- Hartshorn, G.S. (1972). The ecological life history and population dynamics of Pentaclethra macroloba, a tropical wet forest dominant and Straphnodendron excelsum, an occasional associate. Ph.D. Dissertation. Univ. Washington, Seattle.
- Hartshorn, G.S. (1975). A matrix model of tree population dynamics. Tropical Ecological Systems. (Ed. by F.B. Golley and E. Medina). Springer-Verlag, New York.
- Hartshorn, G.S. (1978). Tree falls and tropical forest dynamics. Tropical Trees as Living Systems. (Ed. by P.B. Tomlinson and M.H. Zimmermann). Cambridge Univ. Press, Cambridge.
- Hegnauer, R. (1966). Chemotaxonomie der Pflanzen. Birkhäuser Verlag, Basel, Switzerland.

- Heinselman, M.L. (1973). Fire in the virgin forests of the boundary waters canoe area, Minnesota. Quaternary Res. 3, 329-382.
- Hill, M.O. (1973). Reciprocal averaging: an eigenvector method of ordination. J. Ecol. 61, 237-249.
- Hill, M.O. (1974). Diversity and evenness: a unifying notation and its consequences. Ecology 54, 427-432.
- Holttum, R.E. (1938). Leaf-fall in a non-seasonal climate (Singapore). Proc. Linn. Soc. London. 150th Session: 78-81.
- Hopkins, B. (1965). Vegetation of the Olokemeji Forest Reserve, Nigeria. III. The microclimates with special reference to their seasonal changes. J. Ecol. 53, 123-138.
- Hopkins, B. (1966). Vegetation of the Olokemeji Forest Reserve, Nigeria. IV. The litter and soil with special reference to their seasonal changes. J. Ecol. 54, 687-703.
- Hopkins, B. (1970). Vegetation of the Olokemeji Forest Reserve, Nigeria. VI. The plants on the forest site with special reference to their seasonal growth. J. Ecol. 58, 765-793.

- Horn, H.S. (1975). Markovian properties of forest succession. Ecology and Evolution of Communities. (Ed. by J.L. Cody and J.M. Diamond). Harvard Univ. Press, Cambridge, Mass.
- Horn, H.S. (1976). Succession. Theoretical Ecology. (Ed. by R.M. May). Blackwell, London.
- Hozumi, K., Shinozaki, K. & Tadaki, Y. (1968). Studies on the frequency distribution of the weight of individual trees in a forest stand. I. A new approach toward the analysis of the distribution function and the $-3/2$ power distribution. Jap. J. Ecol. 18, 10-20.
- Hubbell, S.P. (1979). Tree dispersion, abundance, and diversity in a tropical dry forest. Science 203, 1299-1309.
- Hutcheson, K. (1970). A test for comparing diversities based on the Shannon formula. J. Theoret. Biol. 29, 151-155.
- Hutchinson, J. & Dalziel, J.M. (1954-1972). Flora of West Tropical Africa. 3 vols. 2nd ed. revised by R.W.J. Keay and F.N. Hepper. Crown Agents, London.

- Jackson, G. & Gartlan, J.S. (1965). The flora and fauna of Lolui Island, Lake Victoria. A study of vegetation, men and monkeys. J. Ecol. 53, 573-597.
- Janzen, D.H. (1967). Synchronization of sexual reproduction of trees within the dry season in Central America. Evolution 21, 620-637.
- Janzen, D.H. (1969). Seed eaters versus seed size, number, toxicity and dispersal. Evolution 23, 1-26.
- Janzen, D.H. (1970). Herbivores and the number of tree species in tropical forests. Amer. Nat. 104, 501-528.
- Janzen, D.H. (1974). The deflowering of Central America. Nat. Hist. 83, 48-53.
- Janzen, D.H. (1976). Why bamboos wait so long to flower. A. Rev. Ecol. Syst. 7, 347-391.
- Janzen, D.H. (1978). Seeding patterns in tropical trees. Tropical Trees as Living Systems. (Ed. by P.B. Tomlinson and H.H. Zimmermann). Cambridge Univ. Press, Cambridge.

- Jeník, J. & Hall, J.B. (1976). Plant communities of the Accra Plains, Ghana. Folia Geobot. Phytotax., Praha 11, 163-212.
- Jones, E.W. (1950). Some aspects of natural regeneration in the Benin rain forests. Empire For. Rev. 29, 108-124.
- Jones, E.W. (1955-1956). Ecological studies in the rain forest of southern Nigeria. IV. The plateau forest of the Okomu Forest Reserve. Part I and II. J. Ecol. 43, 564-594; 44, 83-117.
- Jones, E.W. (1963). The forest outliers in the Guinea zone of Northern Nigeria. J. Ecol. 51, 415-434.
- Karnig, J.J. & Stout, B.B. (1969). Diameter growth of Northern Red Oak following understorey control. Harvard Black Rock Forest Papers. No.30, Cornwall, N.Y.
- Keay, R.W.J. (1960). Seeds in forest soils. Niger. For. Inf. Bull. n.s. 4, 1-12.
- Klinge, H., Rodrigues, W.A., Brunig, E. & Fittkau, E.J. (1975). Biomass and structure in a central Amazonian rain forest. Tropical Ecological Systems. (Ed. by F.B. Golley and E. Medina). Springer-Verlag, N.Y.

- Knight, D.H. (1975). An analysis of late secondary succession in species-rich tropical forest. Tropical Ecological Systems. (Ed. by F.B. Golley and E. Medina). Springer-Verlag, New York.
- Koelmeyer, K.O. (1960). The periodicity of leaf changes and flowering in the principal forest communities of Ceylon. Ceylon Forester 4, 308-364.
- Koriba, K. (1958). On the periodicity of tree growth in the tropics with reference to the mode of branching, the leaf fall, and the formation of the resting bud. Gdns. Bull. Singapore 7, 11-81.
- Kozlowski, T.T. (1971). Growth and Development of Trees. Vol II. Academic Press, New York.
- Lawson, G.W. (1966). Plant Life in West Africa. Oxford Univ. Press.
- Lawson, G.W. & Jenik, J. (1967). Observations on microclimate and vegetation interrelationships on the Accra Plains (Ghana). J. Ecol. 55, 773-785.
- Lawton, R.M. (1978). A study of the dynamic ecology of Zambian vegetation. J. Ecol. 66, 175-198.
- Lebrun, J. (1936). La forêt équatoriale congolaise. Bull. Agric. Congo Belge 27, 163-192.
- Lee, K.E. & Wood, T.G. (1971). Termites and Soils. Academic Press, London.

- Lieberman, M., John, D.M. & Lieberman, D. (1979).
Ecology of subtidal algae on seasonally devastated
cobble substrates off Ghana. Ecology (In press)
- Liew, T.C. (1973). Occurrence of seeds in virgin
forest topsoil with particular reference to
secondary species in Sabah. Malay. Forest. 36.
185-193.
- Lock, J.M. (1972). The effects of hippopotamus grazing
on grasslands. J. Ecol. 60, 445-467.
- Longman, K.A. & Jenik, J. (1974). Tropical Forest and
its Environment. Longman, London.
- Lowe, R.G. (1968). Periodicity of a tropical rainforest
tree, Triplochiton scleroxylon K. Schum. Commonw.
For. Rev. 47, 150-163.
- MacArthur, R.H. (1972). Geographical Ecology. Harper
and Row, N.Y.
- McKey, D. (1974). Adaptive patterns of alkaloid physiology.
Am. Nat. 108, 305-320.
- McKey, D. (1975). The ecology of coevolved seed dispersal
systems. Coevolution of Animals and Plants. (Ed.
by L.E. Gilbert and P.H. Raven). Univ. of Texas Press,
Austin.

- McKey, D., Waterman, P.G., Mbi, C.N., Gartlan, J.S. & Struhsaker, T.T. (1978). Phenolic content of vegetation in two African rain forests: ecological implications. Science 202, 61-63.
- Madge, D.S. (1966). Leaf fall and litter disappearance in a tropical forest. Pedobiologia 5, 273-288.
- Malaisse, F., Freson, R., Goffinet, G. & Malaisse-Mousset, M. (1975). Litter fall and litter breakdown in miombo. Tropical Ecological Systems (Ed. by F.B. Golley and E. Medina). Springer-Verlag, N.Y.
- Medway, L. (1972). Phenology of a tropical rain forest in Malaya. Biol. J. Linn. Soc. Lond. 4, 117-146.
- Morton, J.K. (1962). The upland floras of west Africa: their composition, distribution and significance in relation to climate changes. Compt. Rend. 4^e Reunion Pleniére AETFAT, Lisbon.
- Njoku, E. (1963). Seasonal periodicity in the growth and development of some forest trees in Nigeria. J. Ecol. 51, 617-24.
- Njoku, E. (1964). Seasonal periodicity in the growth and development of some forest trees in Nigeria. II. Observations on seedlings. J. Ecol. 52, 19-26.

- Nye, P.H. (1955). Some soil-forming processes in the humid tropics. Jour. Soil Sci. 6, 73-83.
- Okali, D.U.U., Hall, J.B. & Lawson, G.W. (1973). Root distribution under a thicket clump on the Accra Plains, Ghana. J. Ecol. 61, 439-454.
- Oosting, H.J. & Billings, W.D. (1951). A comparison of virgin spruce-fir forest in the Northern and Southern Appalachian systems. Ecology 32, 84-103.
- Pannier, F. (1975). Physioecological problems in the tropics. Tropical Ecological Systems. (Ed. by F.B. Golley and E. Medina). Springer-Verlag, N.Y.
- Pianka, E.R. (1978). Evolutionary Ecology. 2nd ed. Harper and Row, N.Y.
- Poore, M.E.D. (1968). Studies in Malaysian rain forest. I. The forest on Triassic sediments in Jengka Forest Reserve. J. Ecol. 56, 143-96.
- Prance, G.T. (1977). Floristic inventory in the tropics: where do we stand? Ann. Missouri Bot. Gard. 64, 659-684.
- Raunkiaer, C. (1934). The Life Forms of Plants and Statistical Plant Geography; Being the Collected Papers of C. Raunkiaer. Clarendon Press, Oxford.
- Reindorf, C.C. (1889). The History of the Gold Coast and Asante. Basel Mission Book Depot, Basel, Switzerland.

- Richards, P.W. (1952). The Tropical Rain Forest.
Cambridge Univ. Press, Cambridge.
- Richards, P.W. (1969). Speciation in the tropical rain forest and the concept of niche. Biol. J. Linn. Soc. 1, 149-153.
- Richards, P.W. (1973). The tropical rain forest. Sci. Amer. 229, 58-68.
- Rollet, B. (1974). L'Architecture des Forêts Denses Humides Sempervirentes de Plaine. Centre Technique Forestiere Tropical, Nogent sur Marne.
- Rowe, J.S. (1961). Critique of some vegetational concepts as applied to the forests of Northwestern Alberta. Can. J. Bot. 39, 1007-1015.
- Salisbury, Sir Edward (1974). Seed size and mass in relation to environment. Proc. Roy. Soc. B. 186, 83-89.
- Serle, W. & Morel, G.C. (1977). A Field Guide to the Birds of West Africa. Collins, London.
- Smythe, N. (1970). Relationships between fruiting seasons and seed dispersal methods in a neotropical forest. Am. Nat. 104, 25-35.
- Snow, D.W. (1965). A possible selective factor in the evolution of fruiting seasons in tropical forests. Oikos 15, 274-281.

- Sokal, R.R. & Rohlf, F.J. (1969). Biometry. W.H. Freeman, San Francisco.
- Stiles, F.G. (1977). Coadapted competitors; the flowering seasons of hummingbird-pollinated plants in a tropical forest. Science 198, 1177-1178.
- Stolzy, L.H. & Barley, K.P. (1968). Mechanical resistance encountered by roots entering compact soil. Soil Sci. 105, 297-301.
- Strong, D.R. (1977). Epiphyte loads, tree falls, and perennial forest disruption: a mechanism for maintaining higher species richness in the tropics without animals. Jour. Biogeogr. 4, 215-218.
- Swaine, M.D. & Beer, T. (1977). Explosive seed dispersal in Hura crepitans L. New Phytol. 78, 695-708.
- Swaine, M.D. & Greig-Smith, P. (1979). An application of principal components analysis to vegetation change in permanent plots. J. Ecol. (In press).
- Swaine, M.D., Hall, J.B. & Lock, J.M. (1976). The forest-savanna boundary in West-Central Ghana. Ghana J. Sci. 16, 35-52.
- Taylor, C.J. (1960). Synecology and Silviculture in Ghana. Thomas Nelson and Sons, Edinburgh.

- Thompson, J.N. & Willson, M.F. (1978). Disturbance and the dispersal of fleshy fruits. Science 200, 1161-1163.
- Tomlinson, P.B. & Raven, P.H. (1977). Perspectives in tropical botany; introduction. Ann. Missouri Bot. Gard. 64, 657-658.
- Toumey, J.W. & Korstian, C.F. (1947). Foundations of Silviculture upon an Ecological Basis. 2nd ed. John Wiley and Sons, N.Y.
- Usher, M.B. (1966). A matrix approach to the management of renewable resources, with special reference to selection forests. J. appl. Ecol. 3, 355-367.
- Usher, M.B. (1969). A matrix model for forest management. Biometrics 25, 309-315.
- Vaartaja, O. (1959). Evidence of photoperiodic ecotypes in trees. Ecol. Monogr. 29, 91-111.
- Walter, H. (1971). Ecology of Tropical and Subtropical Vegetation. Oliver and Boyd, Edinburgh.
- Wareing, P.F., Hanney, C.E.A. & Digby, J. (1964). The role of endogenous hormones in cambial activity and xylem differentiation. The Formation of Wood in Forest Trees (Ed. by M.E. Zimmermann). Academic Press, N.Y.

- Webb, L.J., Tracey, J.C. & Williams, W.T. (1972).
Regeneration and pattern in the subtropical
rainforest. J. Ecol. 60, 675-695.
- Whitmore, T.C. (1974). Change with time and the role of
cyclones in tropical rainforest on Kolombangara,
Solomon Islands. Commonw. For. Inst. 46, 1-78.
- Whitmore, T.C. (1975). Tropical Rain Forests of the Far
East. Clarendon Press, Oxford.
- Whitmore, T.C. (1978). Gaps in the forest canopy.
Tropical Trees as Living Systems (Ed. by P.B.
Tomlinson and M.H. Zimmermann). Cambridge Univ.
Press, Cambridge.
- Wilkins, M.B. (1969). Physiology of Plant Growth and
Development. McGraw-Hill, N.Y.
- Williams, W.T., Lance, G.N., Webb, L.J., Tracy, J.G.
and Dale, M.B. (1969). Studies in the numerical
analysis of complex rain-forest communities. III. The
analysis of successional data. J. Ecol. 57, 515-535.
- 

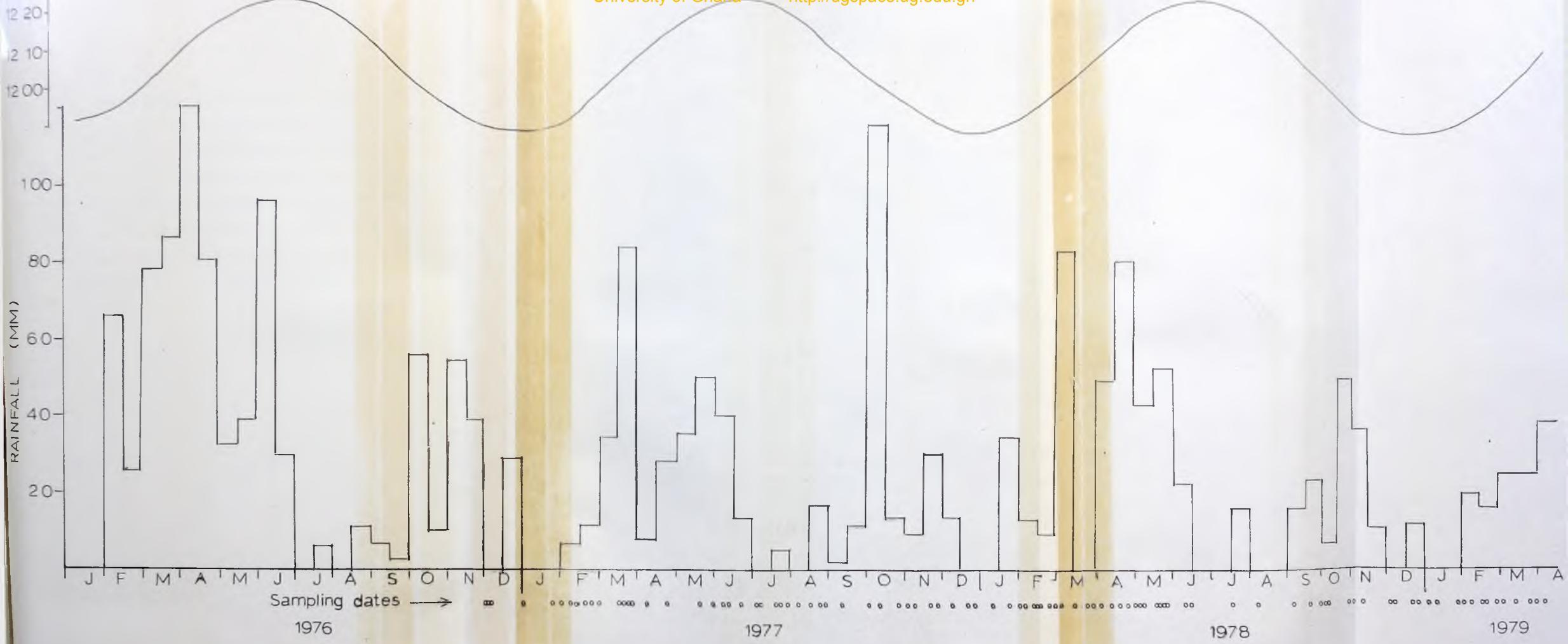

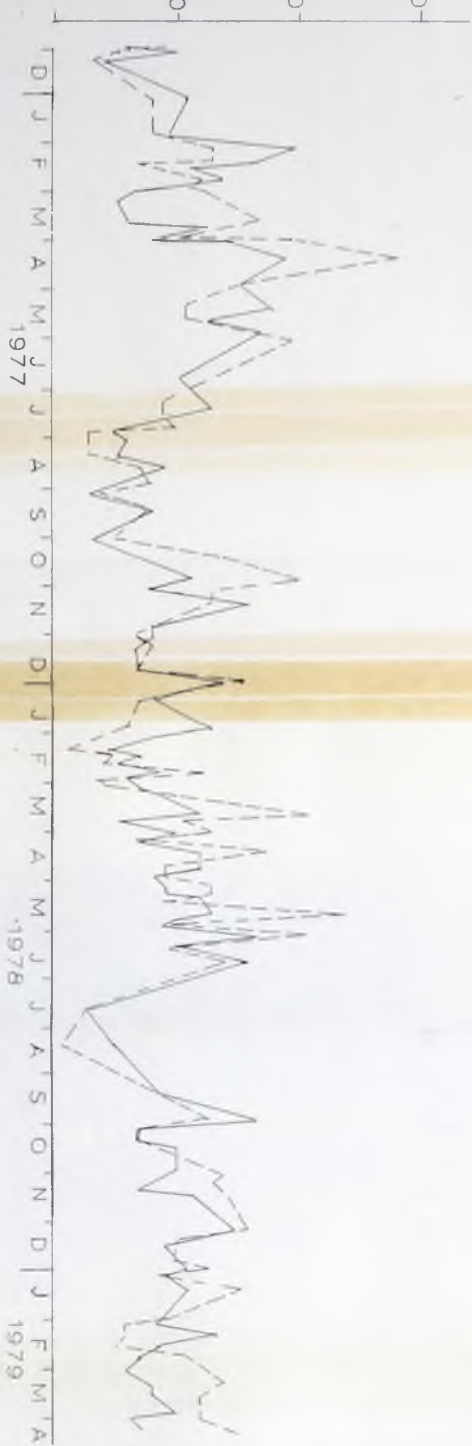

Damaged

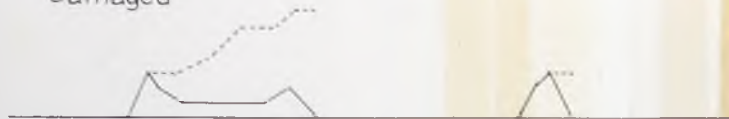

Flushing

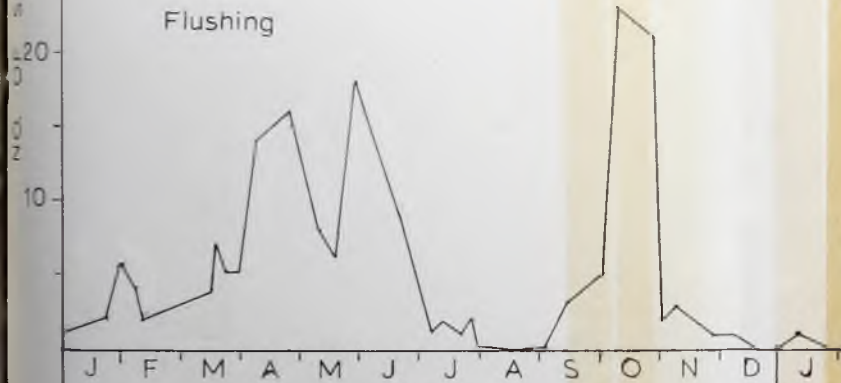

1977



